

The image features a close-up of a grey industrial machine component with a yellow section on the left. The yellow section has the 'FMB' logo in red. The grey section has a complex mechanical assembly with a horizontal metal rod extending from it. The background is a blurred factory floor with workers and other machinery.

**FMB**  
MASCHINENBAU

**BAR LOADING MAGAZINES  
AND WORKPIECE UNLOAD SYSTEMS**

**Made in Germany**

## IN MOTION FOR YOU

### Automation technology for machine tools since 1980

We are the leading manufacturer for automation solution. In Faulbach, Germany, we produce loading and unload solutions for machine tools. Whether sliding headstock lathes, fixed headstock lathes, single-spindle or multi-spindle lathes, FMB offers the optimum bar loading magazine or workpiece unload system for every requirement and purpose. We are an experienced and innovative partner in the field of industrial robots, too. Under the UNIROBOT

brand we produce handling systems tailor-made to customer wishes with individual gripper system and different component storage concepts. Our robot cells are protected by the flexible safety fence system UNIPROTECT. The comprehensive range is supplemented by the UNIPROVE workpiece measuring systems. FMB Maschinenbau supplies everything from a single source: engineering, production, start-up and training.



Our complete range of bar loaders - overview .....	<b>4 - 5</b>
High-quality automation for single- and multi-spindle lathes	
How bar loading magazines work .....	<b>6</b>
Productive, precise, profitable .....	<b>7 - 8</b>
Bar loaders with hydrodynamic bar guidance	
Classic-Line - micromag 20/minimag 20 .....	<b>10 - 12</b>
Eco-Line - turbo 2-20/turbo 3-26/36 .....	<b>14 - 17</b>
Power-Line - turbo 5-65/turbo 8-80/turbo 20-100 .....	<b>19 - 24</b>
For profiled bars	
Bar loaders with ball-bearing mounted bar guidance	
kontur 70 .....	<b>26 - 29</b>
For short bars	
SL 80 V .....	<b>31 - 34</b>
Individual applications for lathes	
Bar loader LSK 38 .....	<b>35 - 36</b>
For flexible use .....	<b>37</b>
Accessories for bar loaders with hydrodynamic and ball-bearing mounted guidance and for short bar loaders	
Loading multi-spindle lathes	
MT-Line .....	<b>38 - 39</b>
Unloading via the sub-spindle	
vario E.....	<b>40 - 43</b>
The FMB Global Service .....	<b>44 - 45</b>
FMB - your partner for automation for more than 25 years .....	<b>46</b>
Handling system UNIROBOT and workpiece measuring system UNIPROVE .....	<b>47</b>



							Page 10 – 12
							Page 10 – 12
							Page 14 – 17
							Page 14 – 17
							Page 15 – 17
							Page 19 – 23
							Page 19 – 23
							Page 20 – 24
							Page 26 – 29
							Page 31 – 34
							Page 35 – 36
							Page 38 – 39
							Page 38 – 39
							Page 40 – 42
							Page 43

# BAR LOADING MAGAZINES



**Bar loaders** feed semi-finished products in the form of bars with different cross-sections fully automatically to lathes or CNC lathes. There are important distinctions between single-spindle and multi-spindle lathes. FMB offers numerous standard solutions mainly for single-spindle lathes. In addition, FMB can also supply special versions

for multi-spindle lathes. Furthermore, FMB also realises individual customer solutions on the basis of tried-and-trusted concepts and many years of experience. These are tailor-made to special requirements and conditions.

## Loading possibilities

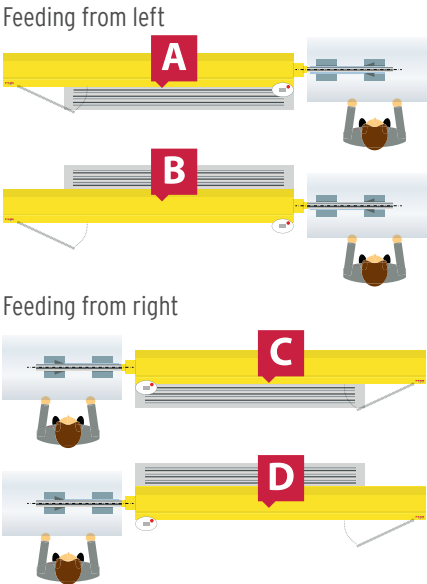

## AUTOMATIC FEEDING - HOW BAR LOADERS WORK

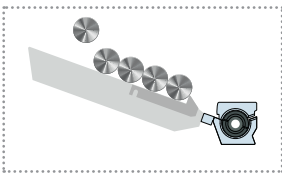

**Step 1: Loading**  
The material bars are set down on the lateral storage system

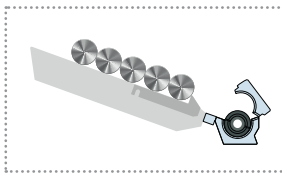

**Step 2: Open channel**  
The cover on the guide channel is opened

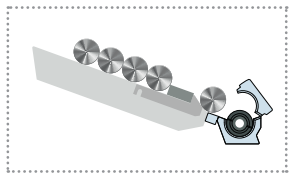

**Step 3: Separate**  
Separate material bars are transferred from the storage system into the guide channel

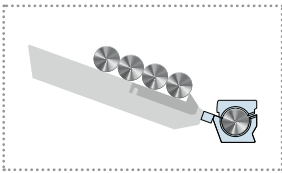

**Step 4: Close channel**  
The guide channel is closed by the cover and flushed with oil

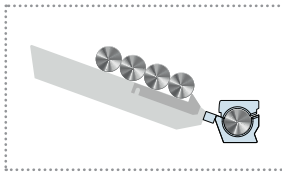

**Step 5: Feeding**  
The material bar is fed into the lathe spindle by the feed system

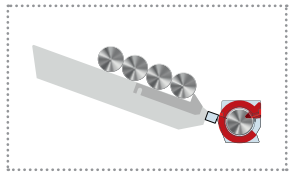

**Step 6: Machining**  
The material bar is guided in the channel during lathing and gradually fed further into the spindle after a part has been completed until the bar has been processed completely



FMB is in constant contact with all renowned machine tool manufacturers in order to guarantee compatibility during the addition of our bar loading magazines for smooth start-up and efficient use. Thanks to the use of modern control concepts, FMB is ideally equipped to deal with customer requirements in the age of Industry 4.0. These include the optional, flexibly selectable data interface for integration in any form of machine or network communication, for example.

## BAR LOADING MAGAZINES WITH HYDRODYNAMIC BAR GUIDANCE

Bar loading magazines with hydrodynamic bar guidance are used in all cases where the material bars to be fed are longer than the spindle length of the lathe. In addition to the staged feed of the material bars, the loading magazine also needs to guide the rotating bars outside the lathe. The 'turbo' principle has proved itself for this task.

The hydrodynamic guidance is suitable for bars with a round, hexagonal or square outer contour, for solid cross-sections as well as for hollow cross-sections. At FMB, all bar loaders of the Classic, Eco and Power-Line are equipped with this innovative guidance feature.

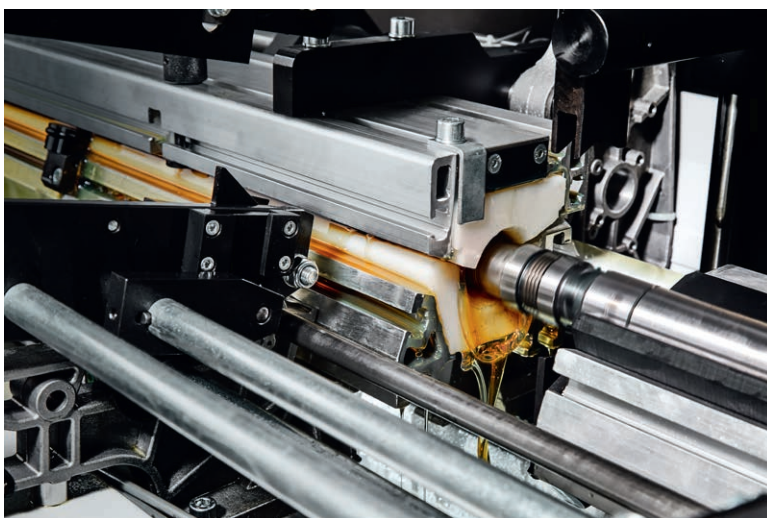
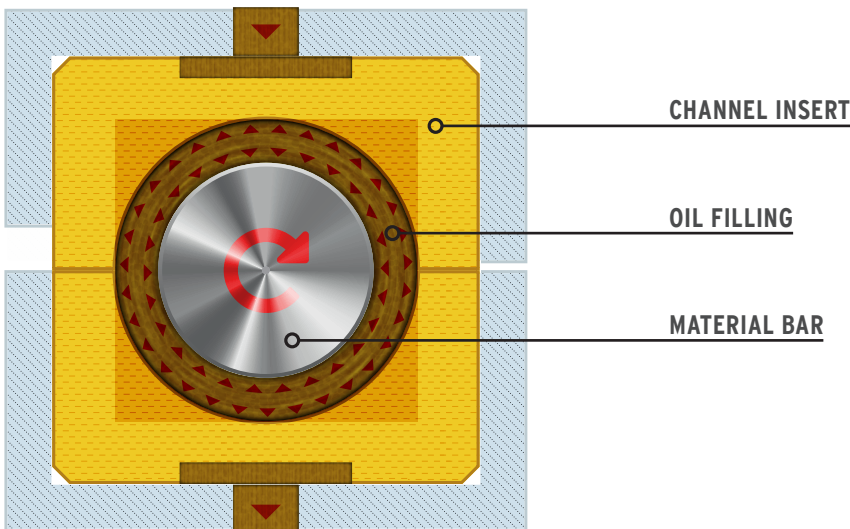

Optimum guidance  
Oil-flushed guide channel with  
hydrodynamic bearing effect

### Function:

The guide channel is flushed with oil. The rotating bar generates turbulences. The bar buoyed up by this and thus avoids contact to the guide channel. Bars with small diameters are guided by an eddy in the centre. In the case of larger bar diameters, the oil film forms a guide for the bar. This has the effect of a hydrodynamic bearing.

### Advantages:

- ▶ No friction on the guide channel – less wear
- ▶ Sturdy, well cushioned guiding of the bar – greater process reliability
- ▶ Lower feed forces – saving energy
- ▶ No damage to the bar surface – higher quality for your products

## CLASSIC-LINE

## ECO-LINE

## POWER-LINE



## USER-FRIENDLY

**Comfortable to hold – detachable control panel**

- ▶ Convenient and user-friendly
- ▶ Robust and reliable
- ▶ Special functions can be programmed to customer specific wishes

**For good guidance – exchangeable guide channel inserts**

- ▶ Fast adaptation of the channel to bar diameter
- ▶ Safe guiding for all bars

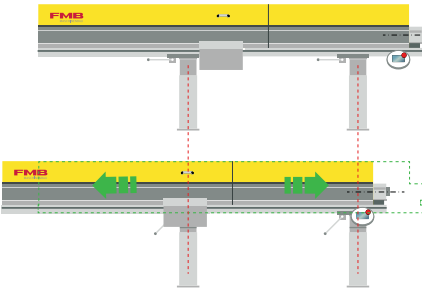
**Variable gap – optional shifting device**

- ▶ Gap of up to 400 mm between lathe and bar loader
- ▶ Optimum access to the lathe for maintenance and service
- ▶ Flexible for fixed and sliding headstock mode
- ▶ Perfect guarantee for a short distance between spindle stock and loading magazine



## OPTIMUM MATERIAL BAR GUIDANCE

**Protect and guide – optional telescopic tube**

- ▶ Bridges the gap between loading magazine and spindle
- ▶ For lathes with moveable spindle stock

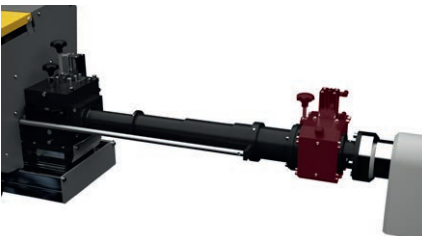
**For maximum precision – movable spindle stock steady**

- ▶ For lathes with large travel distances for the Z-axis
- ▶ With long spindles
- ▶ minimises free bar length between the guide steady and the collet
- ▶ Reduces vibrations for enhanced production precision and better surface quality

**Always a perfect fit – spindle liners as an optional feature**

- ▶ Available for numerous types of lathe
- ▶ Adapt spindle opening to the diameter of the guide channel



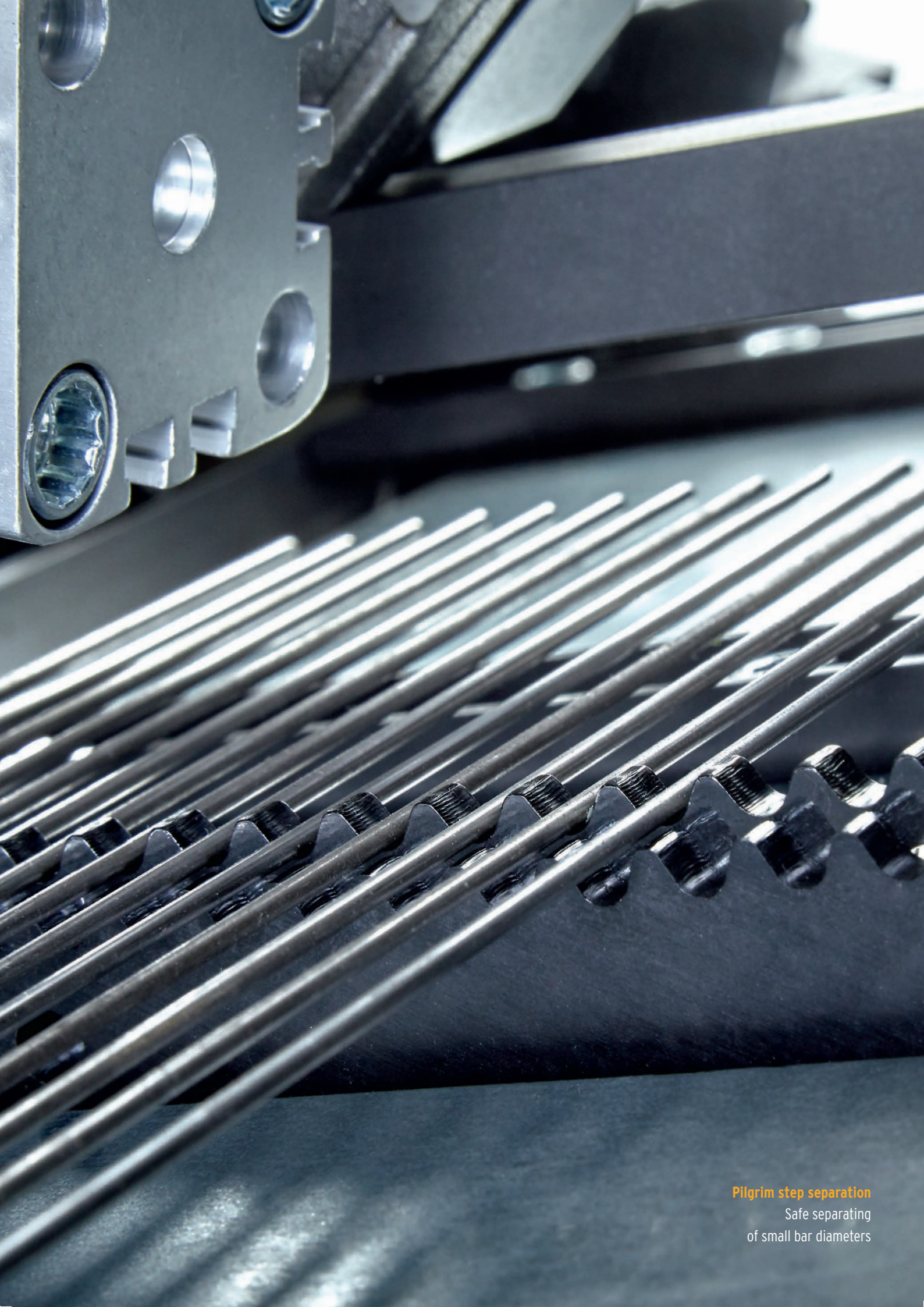

**Pilgrim step separation**  
Safe separating  
of small bar diameters

## CLASSIC-LINE

The bar loading magazines of the Classic-Line are equipped with proven hydrodynamic bar guidance. They work with a single-stage feed. The pusher does not need to swing inwards, thus minimising the

time required for bar changeover. In addition, the bar loaders of the Classic-Line can reliably load bars with even the smallest of diameters.

### MICROMAG 20

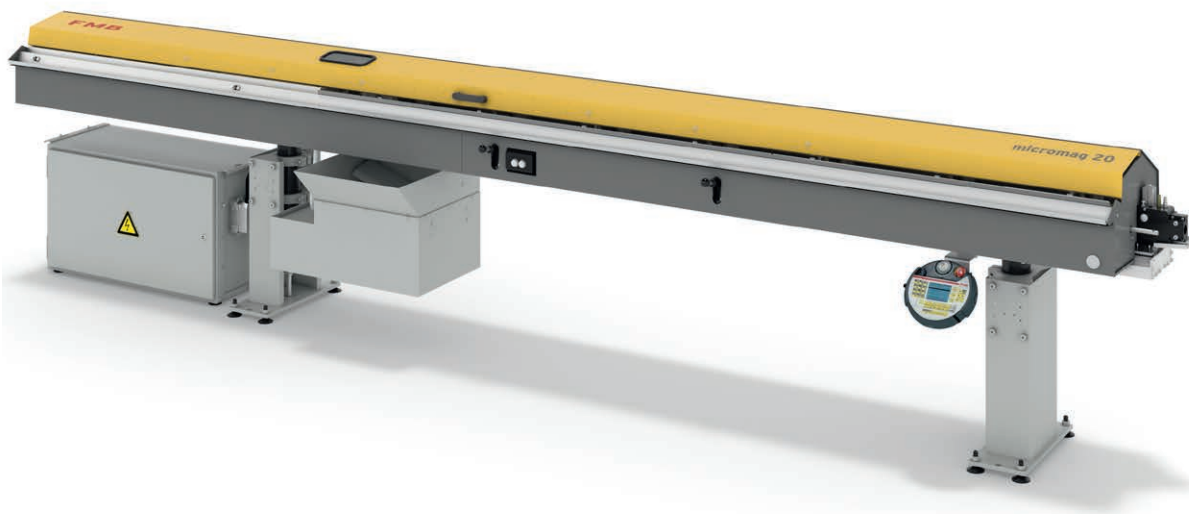

#### Functions and features:

- ▶ Automates sliding headstock lathes with up to 23 mm nominal opening
- ▶ Suitable for smallest bar diameter ranges down to 0.8 mm
- ▶ Reliable separating of even the smallest of bar diameters by swivelling pilgrim step separation on the lateral material storage

### MINIMAG 20

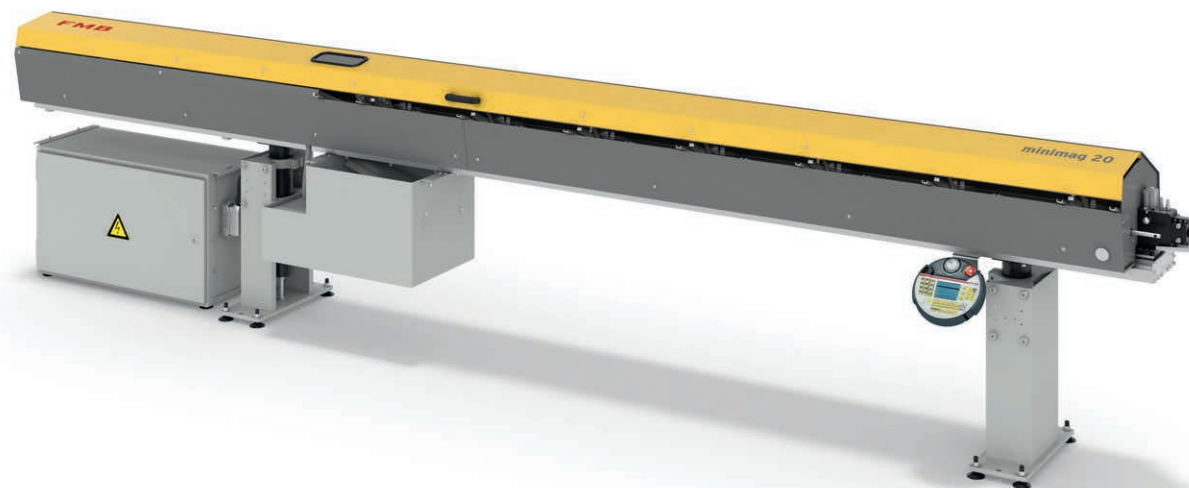

#### Functions and features:

- ▶ For sliding headstock lathes with up to 23 mm nominal opening
- ▶ Processes even the smallest of bar diameters
- ▶ Simple exchanging of the inserts for efficient adaptation of the guide channel to different material diameters

## EFFICIENT AND PRACTICAL HANDLING

### Large stock – bar loading

- ▶ Generous lateral material storage
- ▶ Long-lasting, interruption-free operation guaranteed
- ▶ Reliable feeding independent of the bar diameter

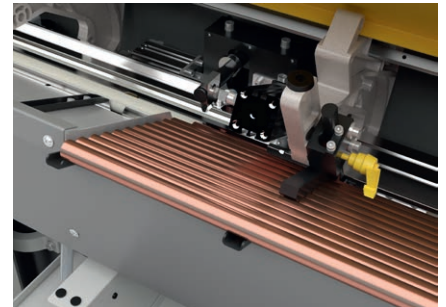

### Safe separating – pilgrim step separation

- ▶ Special feature of the micromag 20
- ▶ Integrated in material storage
- ▶ For bars < 4 mm diameter
- ▶ Can easily be swivelled in if necessary

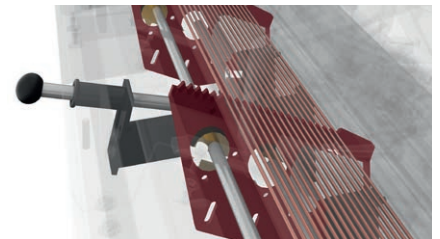

## STABLE DESIGN

### Solid base – machine support

- ▶ Drawn aluminium profile
- ▶ Warp resistant
- ▶ Cushions well
- ▶ Ensures maximum precision in continuous use

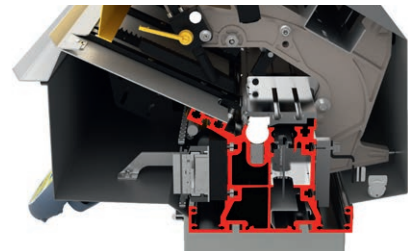

### Reliable function – material gripper

- ▶ Stable, robust design
- ▶ Draws bars on and remnant pieces off
- ▶ Safe in continuous operation

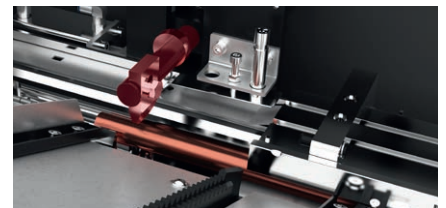

## GUIDE QUALITY

### Variable for changing cross-sections – guide steady

- ▶ Jaw steady for round, square or hexagonal bars
- ▶ Adaptation to the bar diameter by guide elements which are easy to exchange
- ▶ Guides even small bars reliably in the large guide channel



### Feed and spindle combined – synchronizing device

- ▶ With moveable spindle stock e.g. in sliding headstock mode
- ▶ Guarantees absolutely synchronous movement of bar feed and spindle stock
- ▶ Maximum process reliability through mechanical coupling

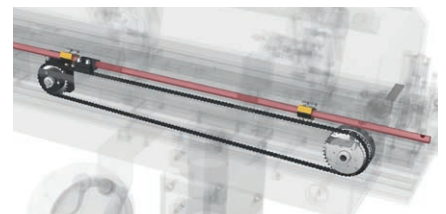

# TECHNICAL DATA

CLASSIC-LINE		MICROMAG 20			MINIMAG 20		
Pusher-Ø (max.)	mm	23			23		
Bar length <sup>1)</sup>	mm	1.600	3.200	4.200	1.600	3.200	4.200
Bar-Ø (min. - max.)	mm	0,8 - 23			2 - 23		
Loading capacity	mm	200			200		
Loading capacity	Items	100 with 2 mm/8 with 23 mm <sup>2)</sup>			100 with 2 mm/8 with 23 mm		
Remnant piece length (max.)	mm	320			420		
Loading time (approx.)	s	-	22 <sup>3)</sup>	-	-	22	-
Feed speed	mm/s	0 - 300			0 - 300		
Operating voltage (50/60Hz)	V	3x 190 - 480 <sup>4)</sup>			3x 190 - 480 <sup>4)</sup>		
LPower requirement	kW	1,5			1,5		
Compressed air connection	MPa (bar)	0,6 (6)			0,6 (6)		
Weight without oil	kg	450	600	800	400	550	650
<b>MACHINE DIMENSIONS</b>							
a	mm	3415	5015	6015	3415	5015	6015
b	mm	1165			1165		
c	mm	850 - 1250			850 - 1250		
d	mm	706			706		
e	mm	441			441		
f	mm	265			265		

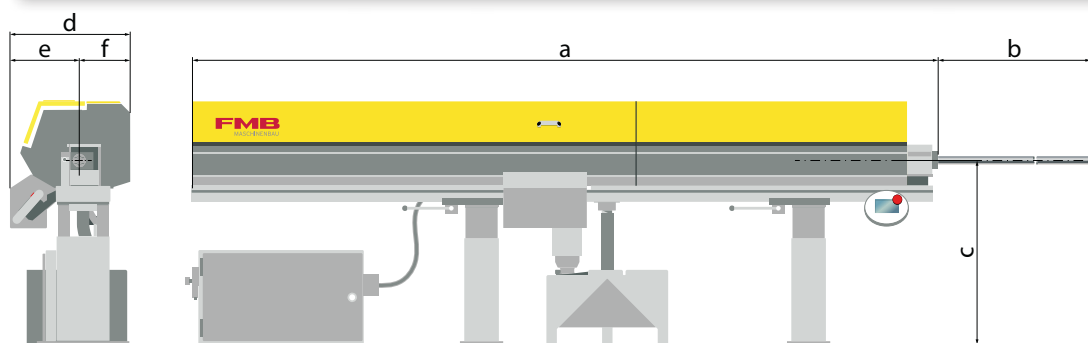

PREFERRED SERIES CAPACITY ADJUSTMENT SETS:					
Capacity adjustment set <sup>5)</sup>	5	7	10	15	23
Round D [mm]	0,8 - 5 <sup>6)</sup>	2 - 7 <sup>6)</sup>	3 - 10 <sup>6)</sup>	8 - 15 <sup>6)</sup>	12 - 23 <sup>6)</sup>
Hexagon AF [mm]	2 - 3	3 - 4	3 - 7	7 - 11	11 - 18
Square AF [mm]	2	2 - 3	3 - 6	6 - 9	9 - 15

1) Special lengths on request 2) 22 items with pilgrim step separation (0.8 - 4 mm) 3) Approx. 3 seconds longer with pilgrim step separation  
 4) Is adjusted on delivery according to lathe specification 5) Intermediate sizes on request 6) Maximum dimension can only be machined by turning the end of the bar

## Loading possibilities

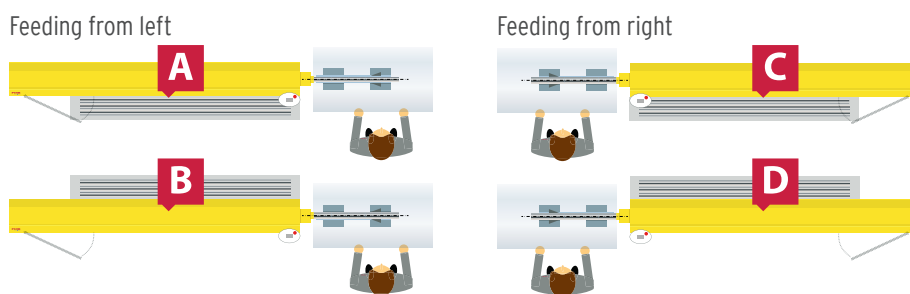

**Optimum material bar guiding**  
Flexible roller steady for  
processing round material

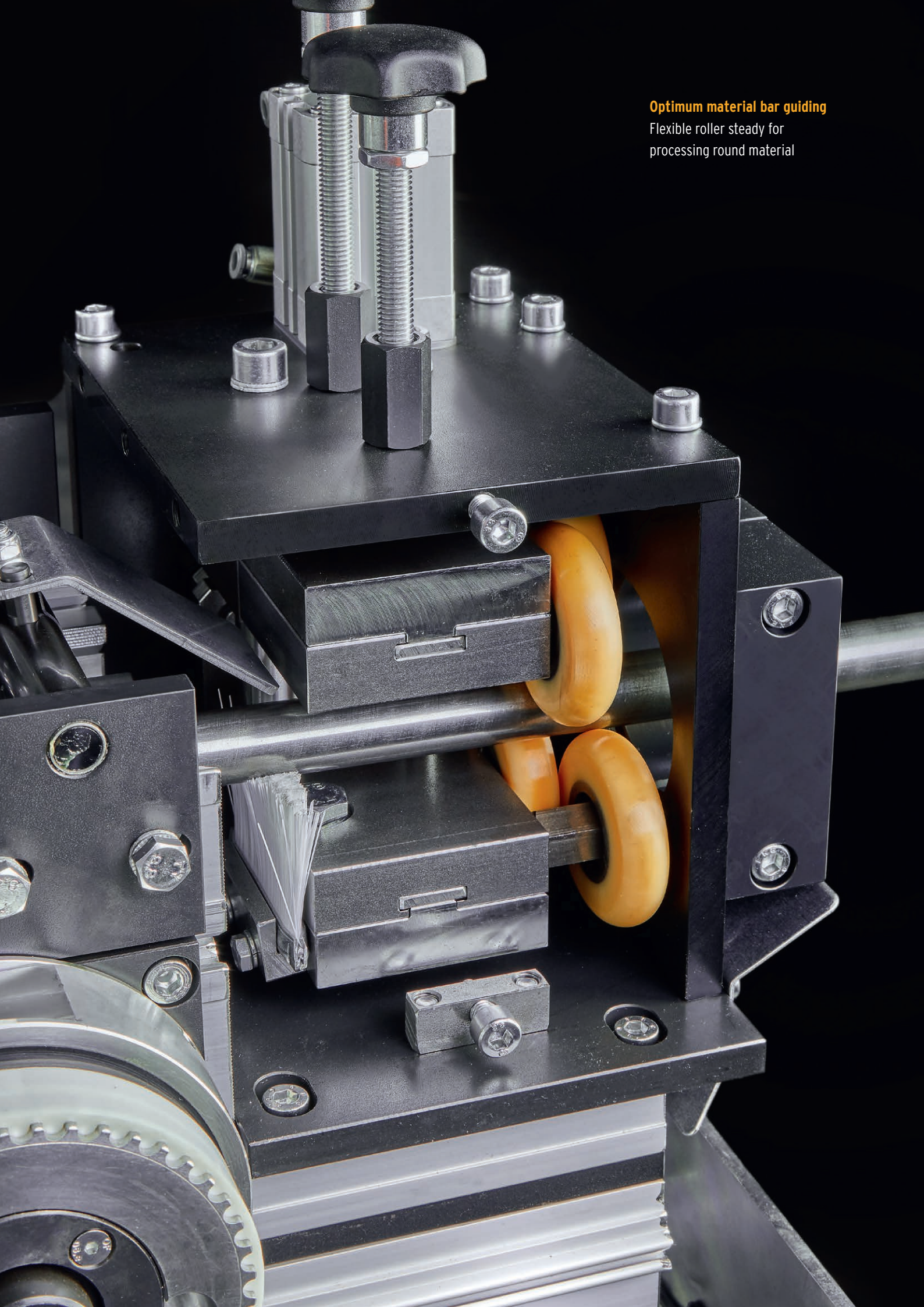

## ECO-LINE

The bar loaders in the Eco-Line series offer optimum space utilization and efficiency during bar changeover. They work on the principle

of two-stage feed. This makes a very compact design possible by swivelling the pusher in.

### TURBO 2-20

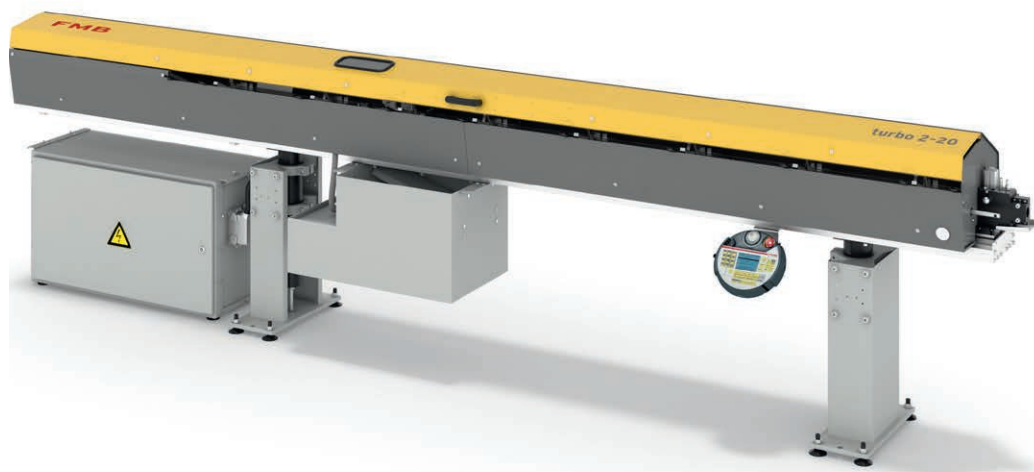

#### Functions and features:

- ▶ For bars from 2 to 23 mm
- ▶ Two-stage feed for compact design and low space requirement
- ▶ Process-reliable with small bar diameters
- ▶ Available as the **turbo 2-20 P** variant with swivelling **pilgrim step separation** for very small bar diameters

### TURBO 3-26



#### Functions and features:

- ▶ For bars with 3 to 26 mm diameter
- ▶ Preferred for sliding headstock lathes
- ▶ Particularly robust and stable thanks to the use of the machine base turbo 3-36
- ▶ Ideal for feeding bars in the small and medium diameter range

## TURBO 3-36



### Functions and features:

- ▶ For bars from 3 to 38 mm diameter
- ▶ Automates fixed and sliding headstock lathes up to 38 mm nominal opening
- ▶ Reliable even for small bar diameters
- ▶ Mature, tried-and-trusted design

## SIMPLE AND CONVENIENT HANDLING

### Independent for a long time – bar loading

- ▶ Generously dimensioned lateral material storage
- ▶ Angle of inclination infinitely adjustable (turbo 3-26/3-36)
- ▶ Flexible and process-reliable, no matter the bar diameter

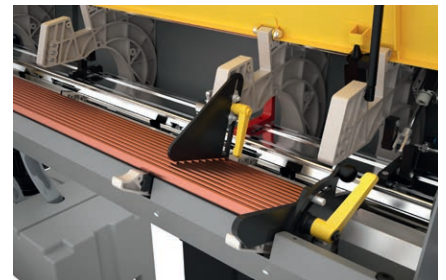

### Separate small bar diameters safely – variant P

- ▶ Special feature of the variant **turbo 2-20 P**
- ▶ Material storage with pilgrim step separation
- ▶ Can be swivelled in from below easily if required
- ▶ Flexible for changing bar diameters
- ▶ Process-reliable separation especially of bars < 4 mm diameter

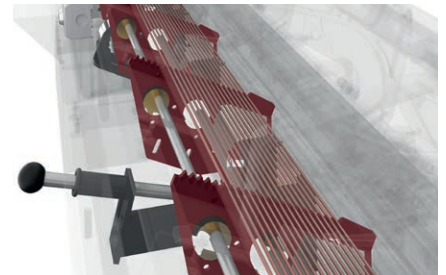

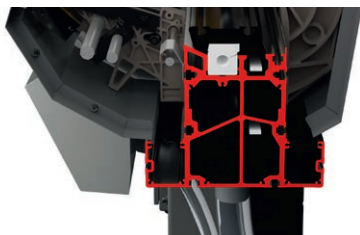

## STABLE DESIGN

### Basis for precision – machine support

- ▶ Warp resistant, drawn aluminium profile
- ▶ Carries all the guide and drive components



### Reliable handling – material gripper

- ▶ Stable gripper design
- ▶ Draws bars on and remnant pieces off safely

## OPTIMUM MATERIAL BAR GUIDANCE



### For varying cross-sections – jaw steady turbo 2-20

- ▶ Guide jaws simple to replace for adaptation to different bar diameters
- ▶ Standard guide for round, square and hexagon-shaped bars
- ▶ Long guide elements for the optimum guiding of even small bar diameters

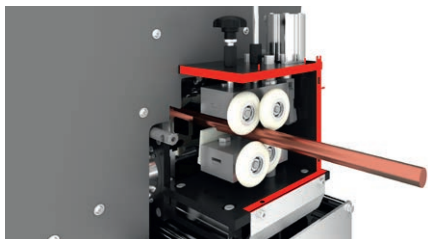

### Adjustable rollers – guide steady turbo 3-26/36

- ▶ Rollers can be flexibly adjusted to the bar diameter
- ▶ Additional guide of the pusher with rollers can be selected
- ▶ Roller units can be replaced quickly and easily by guide jaws when square and hexagon cross-sections are being processed

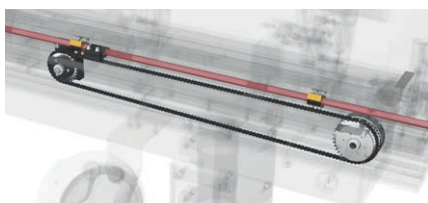

### Synchronized – synchronizing device

- ▶ For lathes with moveable spindle stock (e.g. in sliding headstock mode)
- ▶ Guarantees that the bar feed follows the spindle stock movement synchronously
- ▶ Maximum precision and reliable function thanks to mechanical coupling



# TECHNICAL DATA

ECO-LINE		TURBO 2-20 / P			TURBO 3-26 / 3-36				
Pusher-Ø (max.)	mm	23			26/38				
Bar length <sup>1)</sup>	mm	2200	3200	4200	2200	3200	4200	6200	
Bar-Ø (min. - max.)	mm	2 - 23			3 - 26/38				
Loading capacity	mm	200			200				
Loading capacity	Items.	100 with 2 mm/8 with 23 mm <sup>2)</sup>			66 with 3 mm/7 with 26 mm/5 with 38 mm				
Remnant piece length (max.)	mm	420			450				
Loading time (approx.)	s	-	26 <sup>3)</sup>	-	-	26	-	-	
Feed speed	mm/s	0 - 300			0 - 700				
Operating voltage (50/60Hz)	V	3x 190 - 480 <sup>4)</sup>			3x 190 - 480 <sup>4)</sup>				
Power requirement	kW	1,5			1,5				
Compressed air connection	Mpa (bar)	0,6 (6)			0,6 (6)				
Weight without oil	kg	450	550	650	450/550	650/750	900/1000	1200/1500	
MACHINE DIMENSIONS	a	mm	3215	4215	5215	3320	4320	5320	7320
	b	mm				1278			
	c	mm	850 - 1250			814 - 1494			
	d	mm	601			701			
	e	mm	336			429			
	f	mm	265			272			

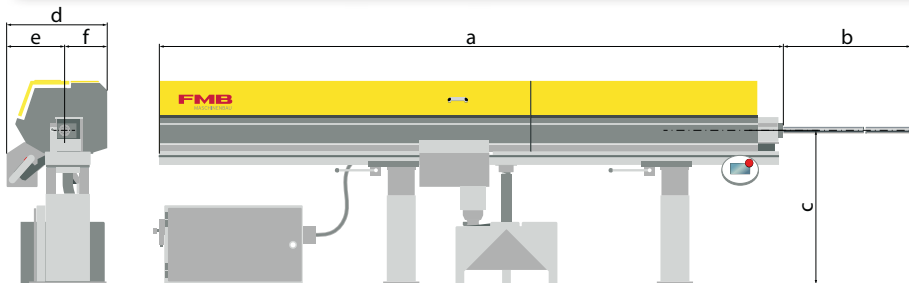

## PREFERRED SERIES CAPACITY ADJUSTMENT SETS:

Capacity adjustment set <sup>5)</sup>	7	10	15	23	26	32	38
Round D [mm]	2 - 7 <sup>6)</sup>	3 - 10 <sup>6)</sup>	8 - 15 <sup>6)</sup>	12 - 23 <sup>6)</sup>	13 - 26 <sup>6)</sup>	23 - 32 <sup>6)</sup>	28 - 38 <sup>6)</sup>
Hexagon AF [mm]	3 - 4	3 - 7	7 - 11	11 - 18	11 - 21	20 - 26	24 - 31
Square AF [mm]	2 - 3	3 - 6	6 - 9	9 - 15	9 - 17	16 - 21	20 - 25
turbo 2-20 / P	✓	✓	✓	✓	✗	✗	✗
turbo 3-26 / 3-36	✗	✓	✓	✗	✓	✓	✓

1) Special lengths on request 2) 22 items with pilgrim step separation (0.8 - 4 mm) 3) Approx. 3 seconds longer with pilgrim step separation  
 4) Is adjusted on delivery according to lathe specification 5) Intermediate sizes on request 6) Maximum dimension can only be machined by turning the end of the bar

## Loading possibilities

Feeding from left

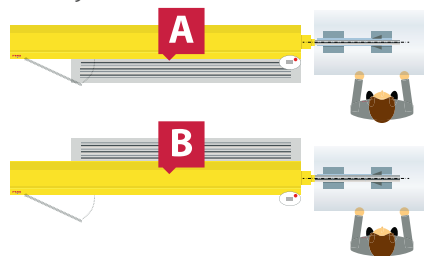

Feeding from right

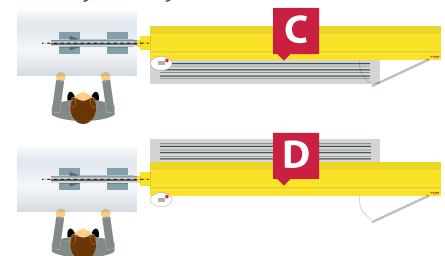

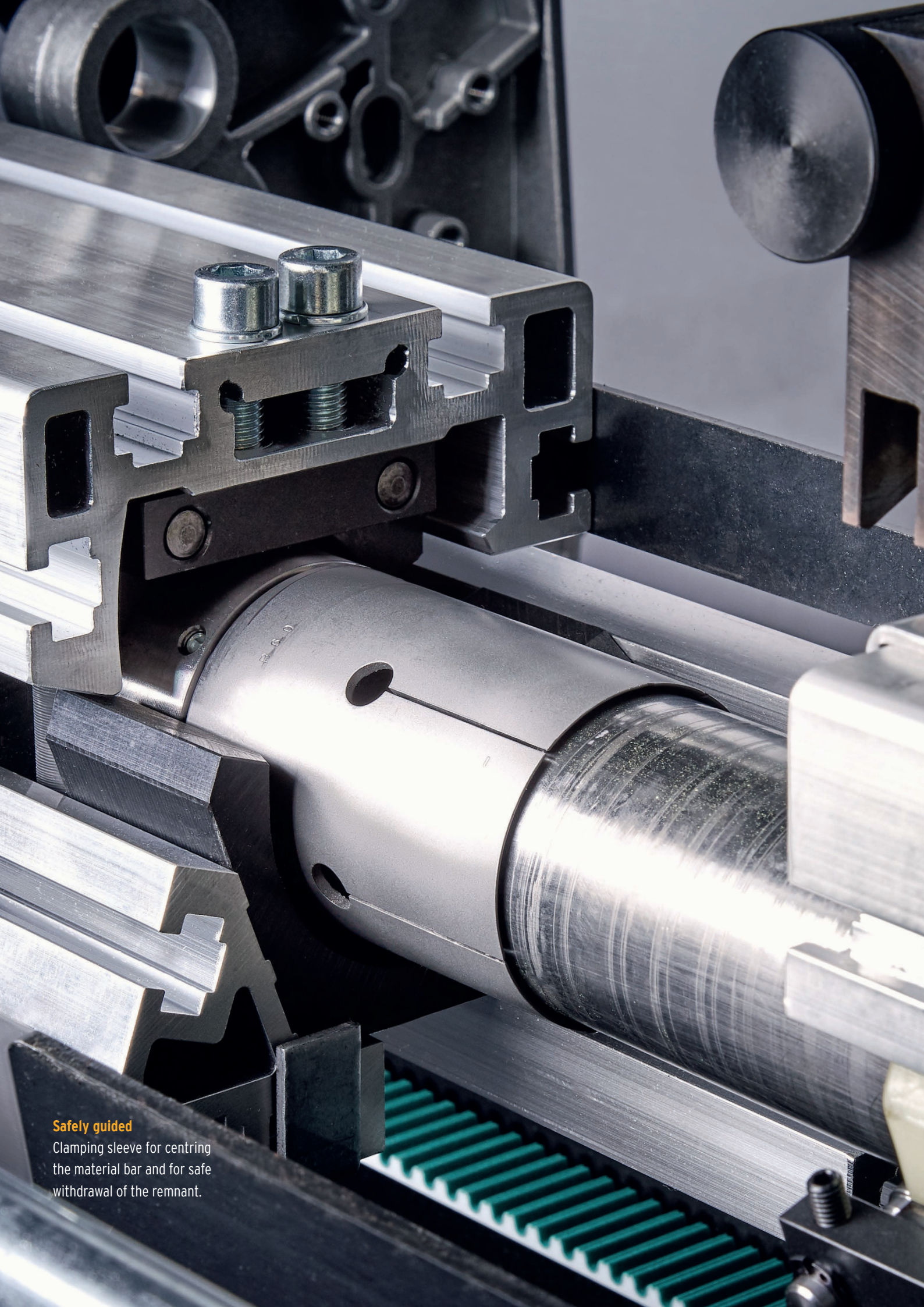

**Safely guided**

Clamping sleeve for centring the material bar and for safe withdrawal of the remnant.

## POWER-LINE

The bar loaders of the Power-Line series are set up extremely compactly and with a small footprint. The two-stage feed with swivelling pusher contributes to this. The solid machine bed made of grey cast

iron provides maximum stability so that large, heavy bars can also be separated and fed precisely and reliably. The Power-Line bar loaders are suitable for bars with a diameter between 5 and 100 mm.

### TURBO 5-65



#### Functions and features:

- ▶ For single-spindle machine up to 65 mm nominal opening
- ▶ Preferred for larger bar diameters from 5 to 65 mm
- ▶ Reliable even for the occasional processing of smaller bar diameters
- ▶ Variant **turbo 5-65 V** with automatically adjustable channel segments is especially flexible, efficient and economical when bar diameters are changed frequently (see p. 22)
- ▶ Variant **turbo 5-65 XT** with linear drive for maximum positioning accuracy during turning processes without mechanical stop (see p. 21)

### TURBO 8-80



#### Functions and features:

- ▶ For single-spindle lathes up to 80 mm nominal opening
- ▶ Preferred for larger bar diameters in the working area from 8 to 80 mm
- ▶ Economical even when smaller bar diameters are processed occasionally

## TURBO 20-100



### Functions and features:

- ▶ For single-spindle lathes up to 100 mm nominal opening
- ▶ Preferred for continuous use with large bar diameters in the working area 20 to 100 mm
- ▶ Efficient even when small bar diameters are processed occasionally
- ▶ Variant **turbo 20-100 V** with automatically adjustable channel segments is especially flexible, efficient and economical when bar diameters are changed frequently (see p. 22)



### FOCUSSED ON PRODUCTIVITY

#### Work for a long time without interruption – bar loading

- ▶ Generously sized material storage
- ▶ Adjustable angle of inclination especially for multi-edge bars
- ▶ Reliable separating of different bar diameters

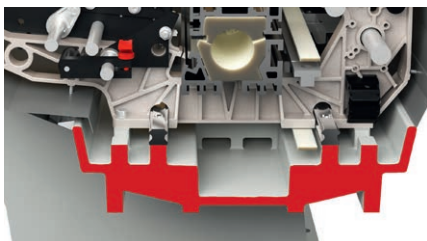

### STABLE DESIGN

#### Basis for precision – machine support

- ▶ Bed made of grey cast iron
- ▶ Sturdy and twist-resistant
- ▶ Secures maximum guide accuracy
- ▶ Guarantees optimum cushioning

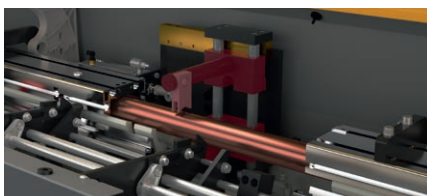

#### Everything firmly in grip – material gripper

- ▶ Particularly sturdy design
- ▶ Safe drawing onto the clamping sleeve even with heavy bars
- ▶ Reliable removal of the remnants

## MAXIMUM GUIDE QUALITY

### Flexible for every diameter – roller steady

- ▶ Roller guide can be adjusted infinitely to the bar diameter
- ▶ Additional support of the pushers with rollers can be selected
- ▶ Can be replaced quickly and easily by guide jaws when square and hexagon bars are to be machined



### Follows exactly – synchronizing device (turbo 5-65)

- ▶ Optimum bar guidance on lathes with moveable spindle stock, in sliding headstock mode, for example
- ▶ Guarantees absolutely synchronous movement of bar feed and spindle stock
- ▶ Extremely process reliable through mechanical coupling

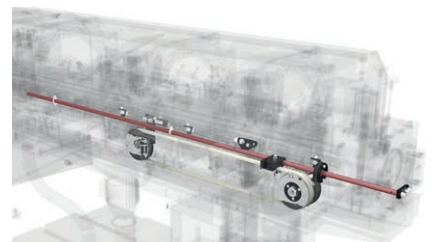

### Precise clamping – pusher holding-down device function (turbo 5-65)

- ▶ Optional holding-down device for the pusher with pneumatically actuated prisms
- ▶ Prevents the pushers canting and tipping during follow-up and with the collet opened
- ▶ Prevents the pusher being clamped in the collet at an angle
- ▶ Additional stabilisation for the pusher during lathing
- ▶ Advantage particularly for lathes with fixed lathe

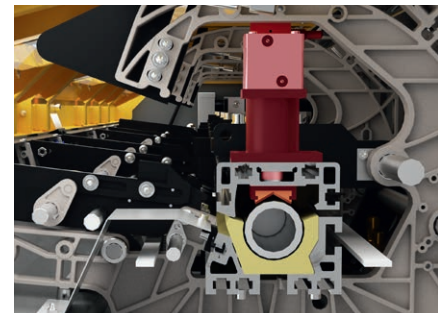

## FEED INTO POSITION WITH GREAT ACCURACY AND WITHOUT STOP VARIANT XT

With the XT variant of the turbo 5-65 bar loader, a high-precision linear drive feeds the bars. This ensures fast bar feed with high positioning accuracy, allowing the bar to be fed exactly and efficiently even without a mechanical stop. This frees up additional tool space in the lathe.

### Precision drive for material feed

A high-precision linear drive enables stop-free insertion at high feed speed.

The advantages are:

- ▶ Time saving and high productivity
- ▶ Protection of the machine tool
- ▶ Additional space for tools since no stop is required
- ▶ Low feed tolerances and low-noise operation

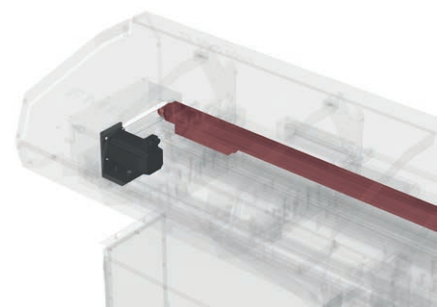

## FLEXIBLE FOR FREQUENTLY CHANGING BAR DIAMETERS VARIANT V

The model variants **turbo 5-65 V** and **turbo 20-100 V** provide an optimum solution for increased production efficiency wherever small batches and frequently changes bar diameters are involved. The V variant has moveable guiding segments that are automatically set to the required material bar diameter, thus preventing the need for refitting the guide channel inserts or changing the pusher over wide diameter ranges.

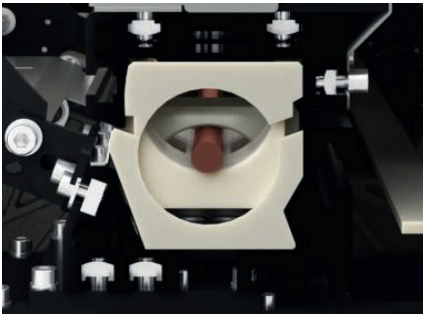

### Fast refitting – adjustable guide channel

- ▶ Automatic diameter setting of the guiding segments in the channel through input at the control panel
- ▶ Flexible work over a wide diameter range without manual changing of the guide channel inserts and the pusher
- ▶ Advantages of the hydrodynamic bearing effect in the closed channel are retained
- ▶ Higher productivity through fewer non-productive times

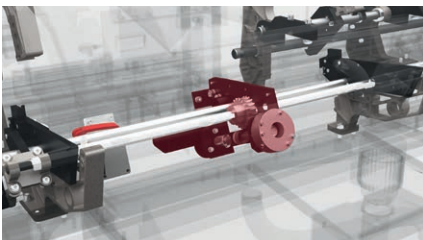

### Flexible for every diameter – material separation

- ▶ Automatically positioning stops for the separation system
- ▶ Reliable, fast conversion to changing bar diameters through input at the control panel

## SAFE GUIDANCE FOR SHORT BARS WITH THE VARIANT TURBO 20-100 V

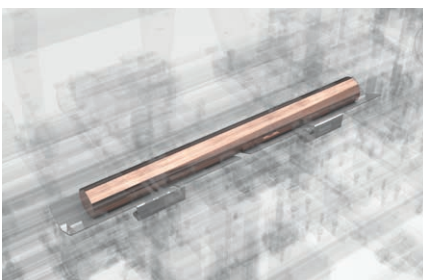

### Sections under control – short loading function (turbo 20-100)

- ▶ For bars from 850 to 1250 mm in length
- ▶ Direct guiding in the lathe spindle
- ▶ Guide must be adapted to the bar diameter by means of spindle liners
- ▶ Precise machining of even large diameters at high speeds

# TECHNICAL DATA

POWER-LINE		TURBO 5-65 / V / XT				TURBO 8-80			
Pusher-Ø (max.)	mm	65				80			
Bar length <sup>1)</sup>	mm	2200 <sup>2)</sup>	3200	4200	6200	3200	4200	6200	
Bar-Ø (min.-max.)	mm	5 - 65				8 - 80			
Loading capacity	mm	240				265			
Loading capacity	Items	48 with 5 mm/3 with 65 mm				33 with 8 mm/3 with 80 mm			
Remnant piece length (max.)	mm	530				580			
Loading time (approx.)	s	-	30	-	-	30	-	-	
Feed speed	mm/s	0 - 1000				0 - 1000			
Operating voltage (50/60Hz)	V	3x 190 - 480 <sup>3)</sup>				3x 190 - 480 <sup>3)</sup>			
Power requirement	kW	2,5				3,5			
Compressed air connection	Mpa (bar)	0,6 (6)				0,6 (6)			
Weight without oil	kg	1500	1800	2300	3000	2800	3300	4300	
MACHINE DIMENSIONS	a	mm	3416	4416	5416	7416	4698	5698	7398
	b	mm	1390				1375		
	c	mm	790 - 1470				870 - 1400		
	d	mm	867				915		
	e	mm	522				590		
	f	mm	345				325		

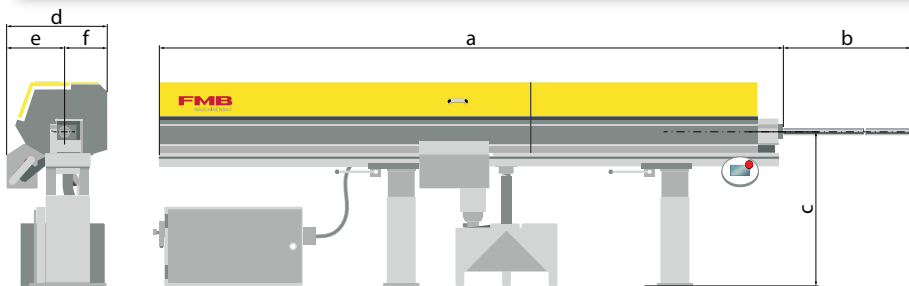

## PREFERRED SERIES CAPACITY ADJUSTMENT SETS:

Capacity adjustment set <sup>4)</sup>	10	15	25	36	42	50	65	80
Round D [mm]	5 - 10 <sup>5)</sup>	8 - 15 <sup>5)</sup>	13 - 25 <sup>5)</sup>	23 - 36 <sup>5)</sup>	30 - 42 <sup>5)</sup>	35 - 50 <sup>5)</sup>	45 - 65 <sup>5)</sup>	60 - 80 <sup>5)</sup>
Hexagon AF [mm]	4 - 7	7 - 11	11 - 20	20 - 30	26 - 31	30 - 42	39 - 55	42 - 67
Square AF [mm]	4 - 6	6 - 9	9 - 16	16 - 24	21 - 25	25 - 34	28 - 45	52 - 55
turbo 5-65	✓	✓	✓	✓	✓	✓	✓	✗
turbo 8-80	✗	✓	✓	✓	✓	✓	✓	✓

1) Special lengths on request 2) Not available as XT or V variant 3) Is adjusted on delivery according to lathe specifications 4) Intermediate sizes on request 5) Maximum dimension can only be machined by turning the end of the bar

## Loading possibilities

Feeding from left

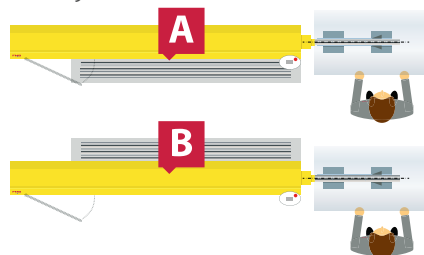

Feeding from right

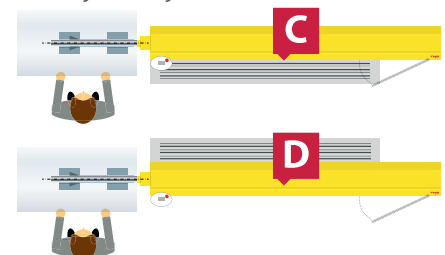

# TECHNICAL DATA

POWER-LINE		TURBO 20-100 / V	
Pusher-Ø (max.)	mm	100	
Bar length <sup>1)</sup>	mm	3200	4200
Bar-Ø (min.-max.)	mm	20 - 100	
Loading capacity	mm	250	
Loading capacity	Items	12 with 20 mm/2 with 100 mm	
Remnant piece length (max.)	mm	580	
Loading time (approx.)	s	32	-
Feed speed	mm/s	0 - 1000	
Operating voltage (50/60Hz)	V	3x 190 - 480 <sup>2)</sup>	
Leistungsbedarf	kW	5,5	
Power requirement	Mpa (bar)	0,6 (6)	
Weight without oil	kg	2700	3150
<b>MACHINE DIMENSIONS</b>			
<b>a</b>	mm	4687	5687
<b>b</b>	mm	1450	
<b>c</b>	mm	880 - 1560	
<b>d</b>	mm	980	
<b>e</b>	mm	655	
<b>f</b>	mm	325	

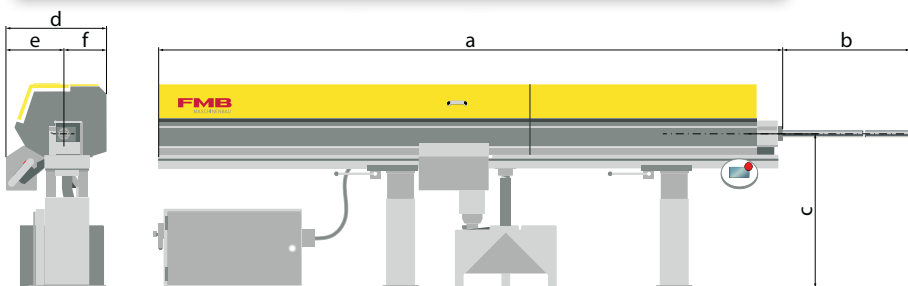

PREFERRED SERIES CAPACITY ADJUSTMENT SETS:						
Capacity adjustment set <sup>3)</sup>	25	42	50	65	80	100
Round D [mm]	20 - 25 <sup>4)</sup>	25 - 42 <sup>4)</sup>	35 - 50 <sup>4)</sup>	45 - 65 <sup>4)</sup>	60 - 80 <sup>4)</sup>	70 - 100 <sup>4)</sup>
Hexagon AF [mm]	11 - 20	20 - 31	30 - 42	39 - 55	42 - 67	61 - 84
Square AF [mm]	9 - 16	16 - 25	25 - 34	28 - 45	52 - 55	50 - 68
turbo 20-100	✓	✓	✓	✓	✓	✓

1) Special lengths on request 2) Is adjusted on delivery according to lathe specifications 3) Intermediate sizes on request 4) Maximum dimension can only be machined by turning the end of the bar

## Loading possibilities

Feeding from left

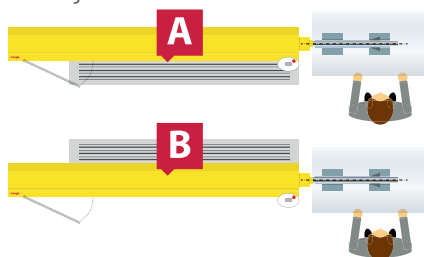

Feeding from right

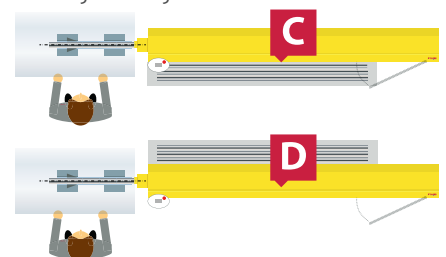



**Stable design**

High-grade base structure of the turbo 5-65

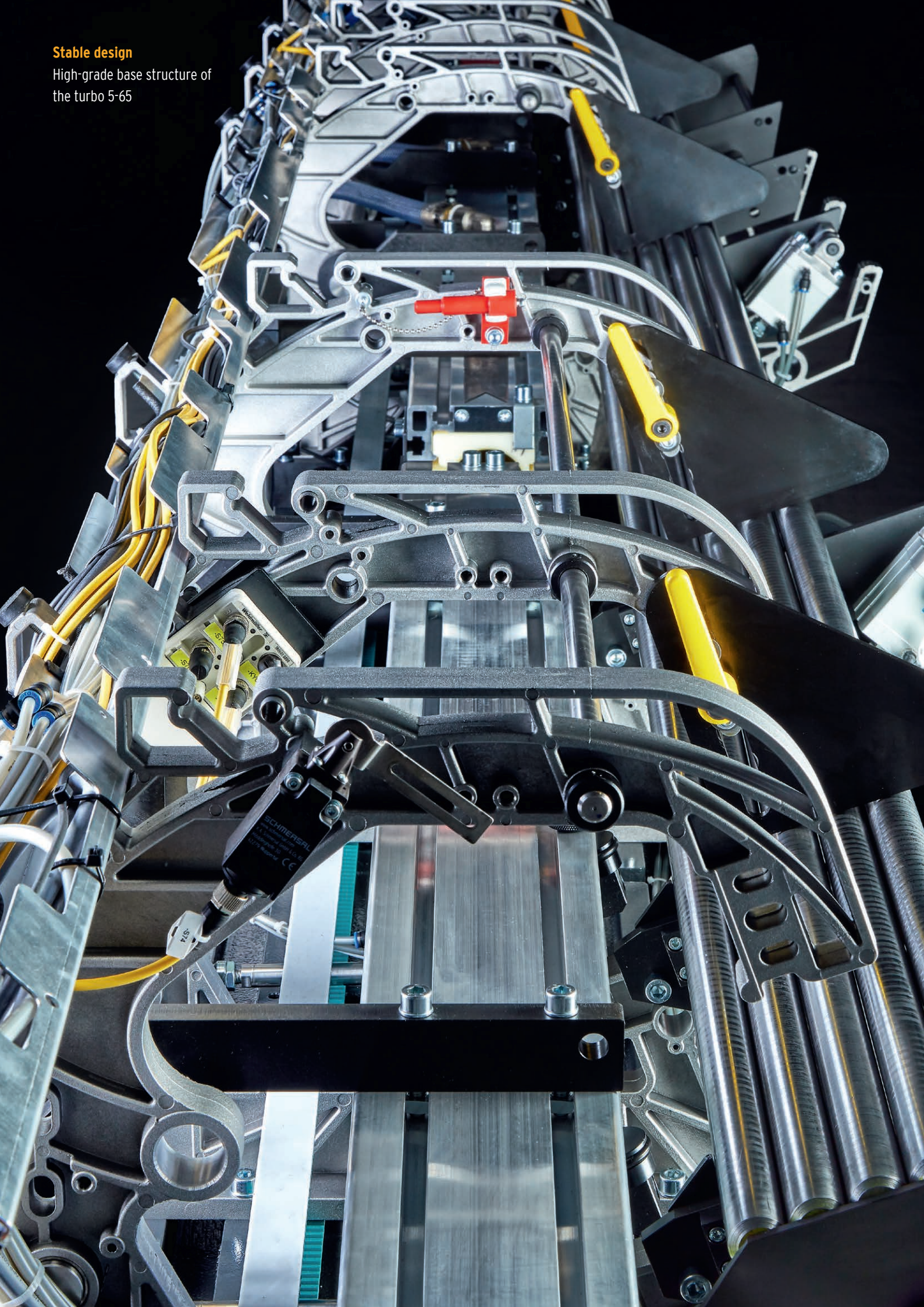

## BAR LOADING MAGAZINES WITH BALL-BEARING MOUNTED BAR GUIDANCE

**Bar loading magazines with ball-bearing mounted bar guidance** from FMB are used in particular for the feeding of bars with profile cross-sections at an exact angle into the lathe. They are fundamentally different from solutions with hydrodynamic guidance. Ball-bearing mounted bushes made of plastic guide the bars without the use of oil. The bars can be longer than the spindle length of the lathe. In addition to feeding, the loading magazine also needs to guide the rotating bars outside the lathe. The bushing-aligned bar loading magazine from FMB can even provide optimum guidance for asymmetrical profile cross-sections. For this purpose, the bushes have a contour

exactly matching the profile to be guided. It is also possible, where the material bars rotate outside the centre of gravity, to weight the bushes statically with counterweights to reduce the vibrations caused by imbalance. The bars are inserted at a precise, repeatable angle into the clamping system of the lathe using an alignment device developed and patented by FMB. This permits the reliable feeding of bars with solid cross-sections made of a range of different materials with custom, hexagonal and square outer contours. The solutions from FMB ensure the ideal automation of fixed headstock single-spindle lathes.

### KONTUR 70

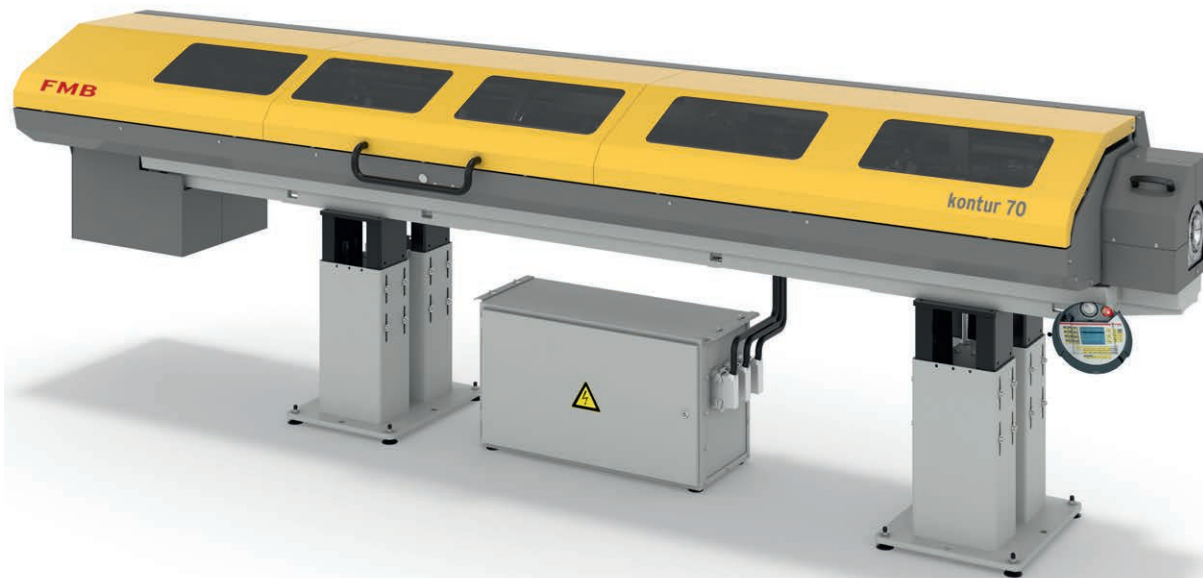

#### Functions and features:

- ▶ For bars with profile cross-sections of 20 to 70 mm external diameter
- ▶ Guiding of the bar without oil in ball-bearing mounted plastic bushes
- ▶ Angle-aligned feeding
- ▶ Compact design thanks to two-stage feed with swivelling pusher
- ▶ Disposal of remnants through the lathe working space

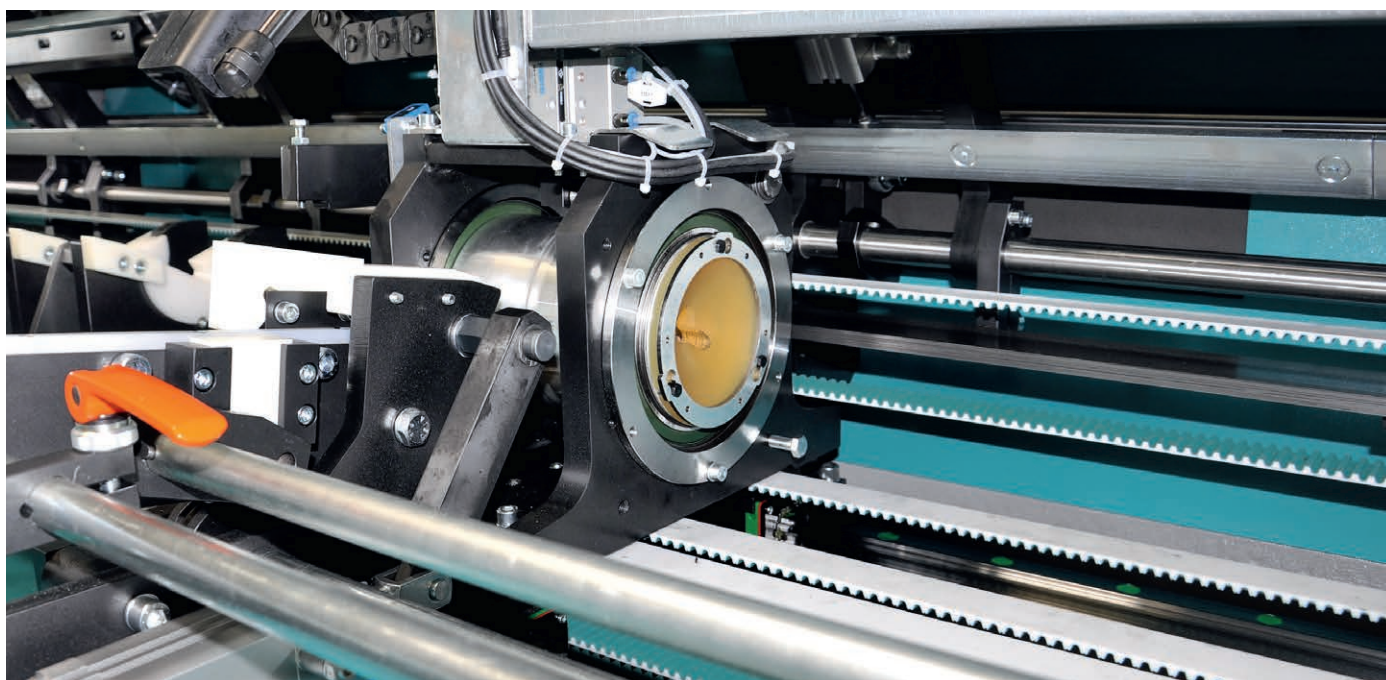
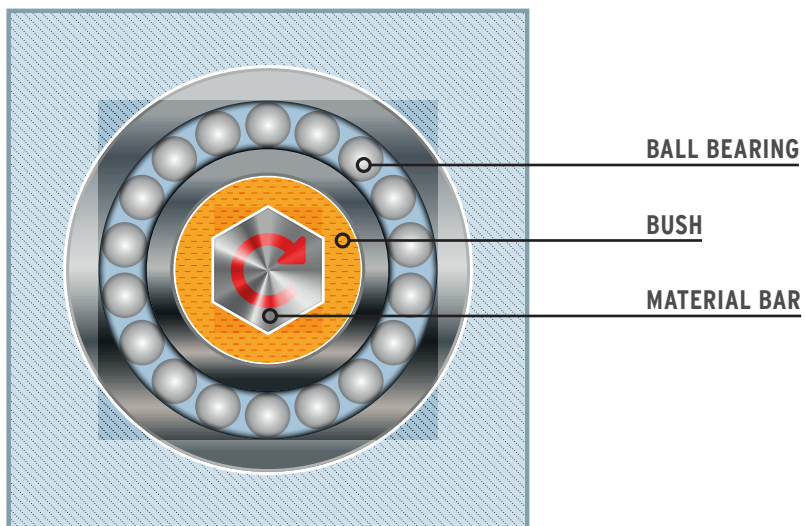

## SOLID BASE

### Designed for precise production – machine support

- ▶ Extremely solid machine support made of grey cast iron
- ▶ Maximum rigidity and vibration damping
- ▶ Sturdy and precise
- ▶ Manages even asymmetrical, unbalanced profiles with ease





## COMFORTABLE OPERATION

### Easy to handle - mobile control panel

- ▶ User-friendly, portable
- ▶ Robust and reliable
- ▶ Flexible programming for customer-specific special functions

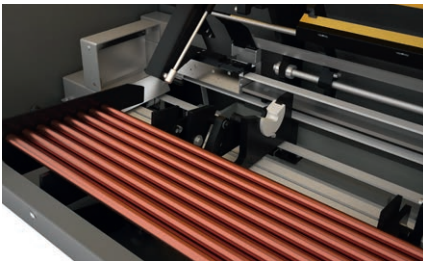

### Work without an operator for long periods – bar loading

- ▶ Generously designed material storage
- ▶ Reserve of between 3 and 13 bars possible depending on diameter
- ▶ Angle of inclination infinitely adjustable
- ▶ Optimum feeding of all cross-sections and diameters

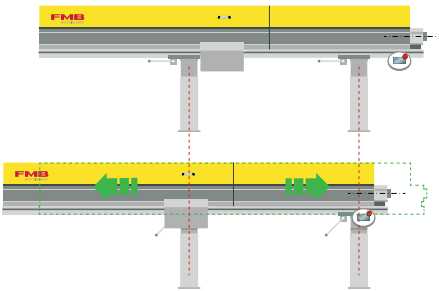

### Easily accessible – shifting device

- ▶ Gap of up to 400 mm to the lathe
- ▶ Optimum access for service and maintenance
- ▶ Minimum gap to spindle stock can be realised

## GUIDE QUALITY



### Profiled – guide bushes

- ▶ Inner contour tailored to profiles
- ▶ Low-vibration feeding of profiles outside the centre of gravity possible thanks to the use of balance weights
- ▶ Optimum longitudinal guiding by eight profile guide bushes in ball-bearing mounted bushing unit

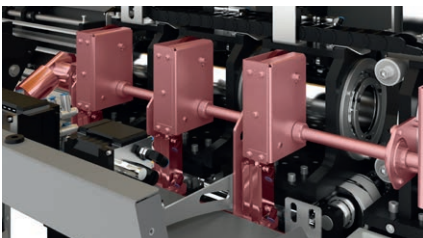

### Exact pre-positioning – alignment unit (option)

- ▶ Automatic setting of the bushes to exact insertion position
- ▶ Process-reliable feeding of the bars even in profiled spindle liners or collets



### Optimum match - spindle liners

- ▶ Available for numerous lathe types
- ▶ Adapt the diameter of the spindle opening to the diameter or profile of the bars
- ▶ Reliable feeding into the spindle
- ▶ Better guidance in the spindle opening

# TECHNICAL DATA

BALL-BEARING MOUNTED		KONTUR 70	
Spindle-Ø (max.)	mm	70	
Bar length <sup>1)</sup>	mm	3200	
Bar-Ø (min. - max.)	mm	20 - 70	
Loading capacity	mm	265	
Loading capacity	Items	13 with 20 mm/3 with 70 mm	
Remnant piece length (max.) <sup>2)</sup>	mm	-	
Loading time (approx.)	s	-	
Feed speed	mm/s	0 - 500	
Operating voltage (50/60Hz)	V	3x 190 - 480 <sup>3)</sup>	
Power requirement	kW	5	
Compressed air connection	Mpa (bar)	0,6 (6)	
Weight	kg	2000	
<b>MACHINE DIMENSIONS</b>			
a	mm	4700	
b	mm	1650	
c	mm	820 - 1500	
d	mm	966	
e	mm	641	
f	mm	325	

- 1) Special lengths on request
- 2) Machine-dependent; disposal of remnants through the lathe
- 3) Is adjusted on delivery according to lathe specifications

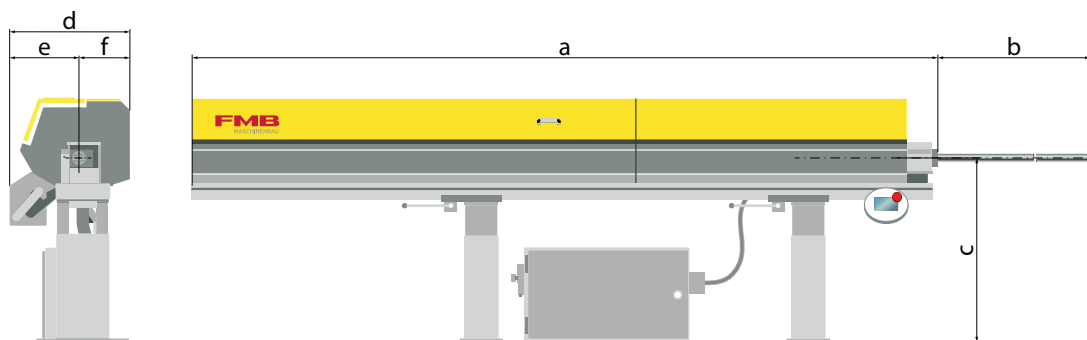

## Loading possibilities

Feeding from left

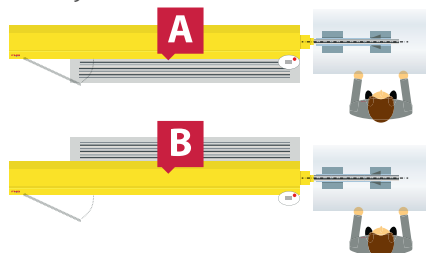

Feeding from right

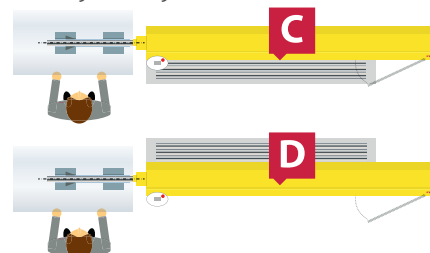



**Flexible material bar guidance**  
Automatically adjustable V-channel  
on SL 80 V

# BAR LOADING MAGAZINES FOR SHORT BARS

Short bar loaders of the SL series stock the material bars and feed them into the lathe spindle. Because if lathes work with bars with a maximum length corresponding to the spindle passage, the bar loading magazine no longer has a guide function. The open V-channel serves as a guide, since the sturdy, exact guiding of the rotating bar is not required. This method permits feeding of round and profiled solid

bars made of metal, NF metals as well as thermoplastic and thermosetting materials. Matching spindle liners are required for guiding the material bars (accessories from FMB). The short bar loaders from FMB are ideal for the automation of single-spindle lathes for the flexible small batch production of precision parts, even with larger bar diameters.

## HOW THEY WORK

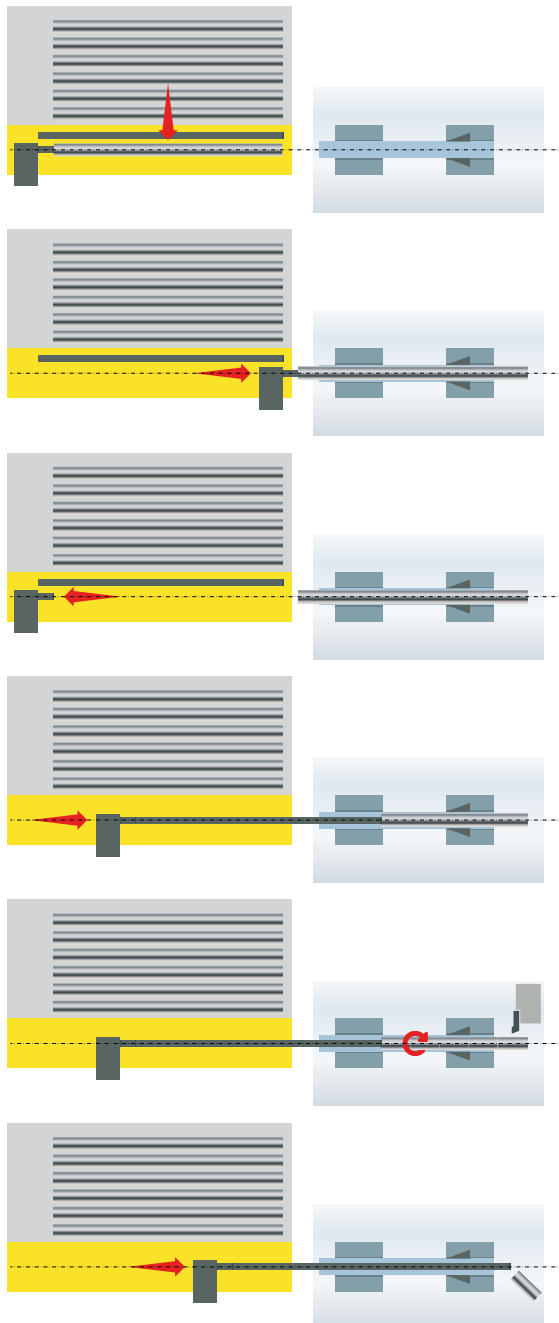

The lateral material storage of the bar loader stocks short bars made of steel, NF metals or plastics, one bar is separated

The separated material bar is fed into the lathe clamping device by the lathe spindle

The bar feed moves back and the pusher changes from the waiting position to the feed position behind the material bar

The material bar is fed to the first machining position by the pusher

The lathe produces workpieces in the fixed headstock mode, the material bar is gradually fed until it has been worked completely

The pusher of the bar loader pushes the remnant out through the lathe clamping device – the entire cycle starts again

## SL-LINE

The **SL-Line** has an impressive modern design and many innovative detailed solutions in order to offer the optimum solution for a wide range of different requirements related to bar section feed. It has a modular

design, with differences including the pusher lengths available and the supply options for material bars.

### SL 80 V



#### Functions and features:

- ▶ Variable "V-Channel" as bar guide with fully automatic adaptation to the diameter or the profile shape
- ▶ Continuous "V-Channel" for the efficient feeding of short bar sections
- ▶ Small footprint thanks to integrated longitudinal displacement system
- ▶ Choice of different material storage modules:
  - Long material storage with angle adjustment for maximum flexibility (Ramp version)
  - Long material storage with cycle belt for position-aligned feeding of profile material
  - Short material storage as compact "Single bar feed" for very small batches
  - Material storage with lift system for the ergonomic loading of larger bar diameters



SL 80 V as compact "single bar feed"



SL 80 V with ergonomic lift system

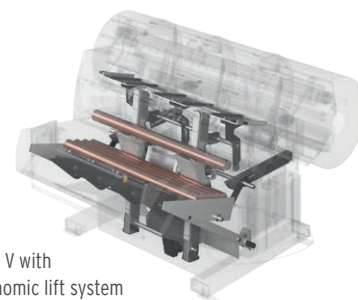

### VARIABLE AND FULLY AUTOMATIC



#### Efficient feeding - "V-Channel"

- ▶ Servo-electric adjustment of the "V-Channel geometry" for automatic adaptation to the diameter or profile shape selected
- ▶ Continuous "V-Channel" for the efficient feeding of short bar sections.
- ▶ Free choice of bar centre, also for off-centre feeding and for the precise angular feeding of profile material



## PRACTICAL OPERATION AND HANDLING

### Always on hand – mobile control panel

- ▶ Simple and convenient operation - the ERGOlogic control from FMB
- ▶ Modern touch operation with generously sized 8.4" screen
- ▶ Ergonomically designed shape with integrated magnetic holders for flexible attachment in the operator's working environment



### Modern user guidance – touch operation

- ▶ Intuitive operating concept for a faster user learning phase
- ▶ Assistant functions for guided set-up for inexperienced operators
- ▶ Selection of different user roles to specify access rights to defined functions and setting values
- ▶ Comprehensive storage options for order-related parameter sets for the fast set-up of repeat production orders



## HIGH PRODUCTIVITY

### Precise and quiet – drive concept

- ▶ All axes with servo-electric drives for quiet running, high positioning accuracy
- ▶ Short bar changeover times thanks to optimised movement processes and the use of highly dynamic drives
- ▶ High energy efficiency thanks to the use of fully electric drives and low-friction linear guides
- ▶ Reloading possibility for material bars even during the production process thanks to safe switch-off of critical movements

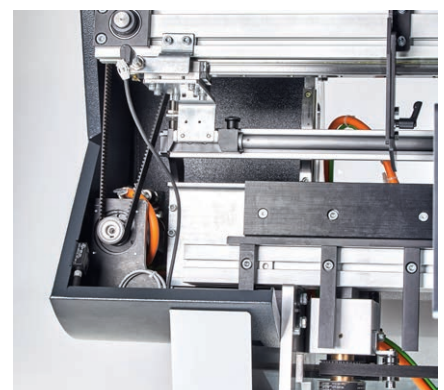

## SHORT SET-UP TIMES

### Good accessibility – displacement system

- ▶ Fast accessibility to the end of the spindle thanks to longitudinal displacement system integrated in the machine bed
- ▶ Small footprint, since only the upper section of the loading magazine is displaced.
- ▶ Additional lateral displacement of the loading magazine using a rail system integrated in the machine base available as an option



### Simple retooling – pusher quick-change system

- ▶ Simple replacement of the pusher through the quick-change system
- ▶ Good accessibility thanks to wide opening of the machine panelling
- ▶ Integrated rack on the machine stand for fast access to the pushers available

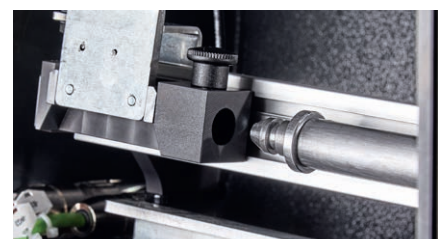

# TECHNICAL DATA

SL-LINE		SL 80 V	
Spindle-Ø (max.)	mm	<b>80</b>	
Bar length <sup>1)</sup>	mm	1100	1400
Bar-Ø (min. - max.)	mm	6 - 80	
Storage system	-	Ramp	
Loading capacity	mm	560	
Loading capacity	Items	93 with 6 mm/7 with 80 mm	
Loading time (approx.) <sup>2)</sup>	s	15	16
Feed speed	mm/s	0 - 1500	
Operating voltage (50/60Hz)	V	3x 190 - 480 <sup>3)</sup>	
Power requirement	kW	2	
Compressed air connection	Mpa (bar)	Not necessary	
Weight	kg	500	600
Available pusher diameter	mm	5 <sup>4)</sup> , 8, 12, 20	
Loading options	-	A, B, C, D	

1) Bar length must not exceed spindle length  
 2) With selection of remnant piece ejection by following material bar  
 3) Is adjusted on delivery according to lathe specifications  
 4) Turning process may only be possible after complete pusher retraction

## Machine dimensions

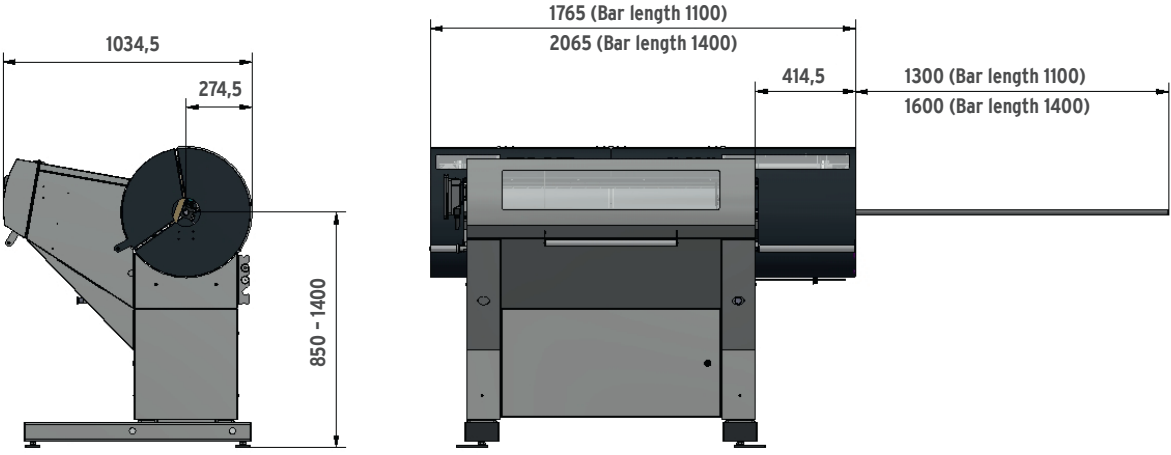

## AREA OF APPLICATION

Thanks to the innovative separation and guide system for the material bars, all common types of material as well as profile cross-sections of almost any shape can be fed:



# BAR LOADING MAGAZINES FOR INDIVIDUAL APPLICATIONS

**Solutions individually tailored to requirements** are an important feature of the FMB service idea. Bar loaders are not exclusively suitable for the provision and feeding of bars or bar sections to lathes. They can also provide an economic automation solution for laser cutter machine and saw workflows. We used standardised components to realise

low-cost yet solid and reliable solutions. This allows not only bars but also sections and bar-shaped blanks to be fed for further machining. FMB designs and realises suitable automation solutions for numerous different requirements.

## LSK 38

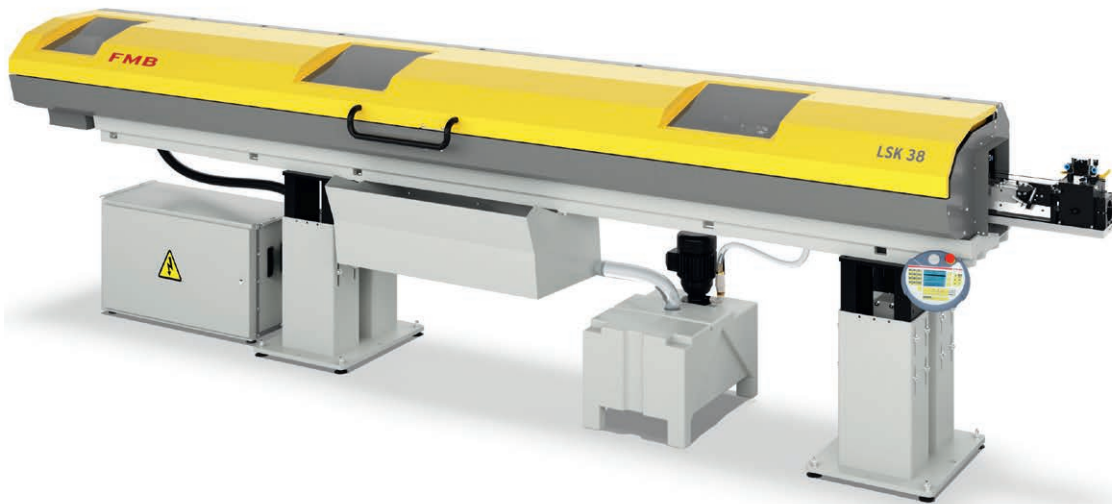

One prime example of how FMB caters to individual customer requirements is the optimum solution for guiding material bars on lathes where the spindle stock moving along the Z-axis causes substantial differences in guide lengths. The answer is the moving guide channel concept patented by FMB. The whole guide channel is mounted

moveable on linear tracks and coupled with the end of the lathe spindle. This means the guide channel follows every movement of the spindle stock and there is no longer an unguided area of the material bar between the loading magazine and lathe at any time. The result is a notably more efficient turning process which maintaining the quality of the part.

## OPTIMUM MATERIAL BAR GUIDANCE

### Always close up

- ▶ The oil-flushed and moving guide channel retains all the advantages of the hydrodynamic bearing effect
- ▶ The constant closeness to the spindle guarantees optimum guidance and thus low-vibration running

### Flexible for every diameter – guide steady

- ▶ Prism guide can be adjusted infinitely to the bar diameter
- ▶ Can be replaced quickly and easily by guide jaws when square and hexagon bars are to be machined
- ▶ Long prism guide support the machining of small bar diameters even in the large guide channel

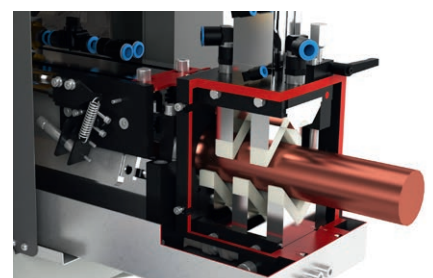
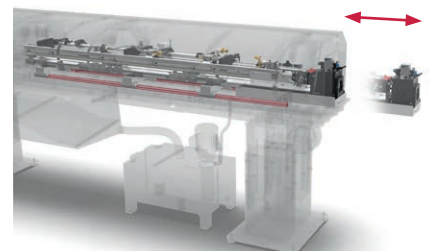

# TECHNICAL DATA

INDIVIDUAL APPLICATIONS		LSK 38		
Pusher-Ø (max.)	mm	44 <sup>2)</sup>		
Bar length <sup>1)</sup>	mm	2200	3200	4200
Bar-Ø (min. - max.)	mm	5 - 42		
Loading capacity	mm	240		
Loading capacity	Items.	48 with 5 mm/5 with 42 mm		
Remnant piece length (max.)	mm	600		
Loading time (approx.)	s	-	30	-
Feed speed	mm/s	0 - 1000		
Operating voltage (50/60Hz)	V	3x 190 - 480 <sup>3)</sup>		
Power requirement	kW	2,5		
Compressed air connection	Mpa (bar)	0,6 (6)		
Weight without oil	kg	1500	1800	2400
<b>MACHINE DIMENSIONS</b>				
<b>a</b>	mm	3781	4781	5781
<b>b</b>	mm	1278		
<b>c</b>	mm	790 - 1470		
<b>d</b>	mm	885		
<b>e</b>	mm	540		
<b>f</b>	mm	345		

- 1) Special lengths on request
- 2) End of pusher with shoulder Ø 42
- 3) Is adjusted on delivery according to lathe specifications
- 4) Intermediate sizes on request
- 5) Maximum dimension can only be machined by turning the end of the bar

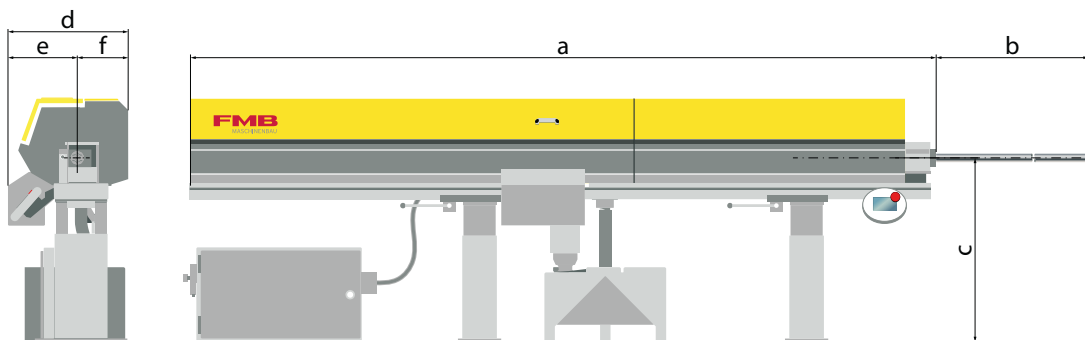

PREFERRED SERIES CAPACITY ADJUSTMENT SETS:					
Capacity adjustment set <sup>4)</sup>	10	15	25	32	44
Round D [mm]	5 - 10 <sup>5)</sup>	8 - 15 <sup>5)</sup>	13 - 25 <sup>5)</sup>	23 - 32 <sup>5)</sup>	30 - 42 <sup>5)</sup>
Hexagon AF [mm]	4 - 7	7 - 11	11 - 20	20 - 26	26 - 34
Square AF [mm]	4 - 6	6 - 9	9 - 16	16 - 21	21 - 28

## Loading possibilities

Feeding from left

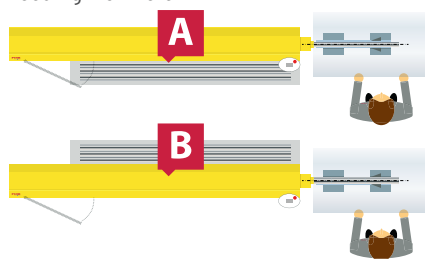

Feeding from right

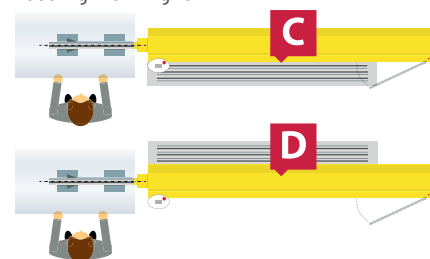

## ACCESSORIES

**Genuine accessories from FMB** ensure the long-term universal, flexible and economic use of the bar loaders. They guarantee dependable, process-reliable operation of the systems.

### CAPACITY ADJUSTMENT SETS

#### Optimum match - guide channels

- ▶ Use with magazines with hydrodynamic guidance
- ▶ Available in a large number of different diameter grades
- ▶ Guide safely and with low vibration



### CLAMPING SLEEVES/CLAMPING MANDRELS

#### Safe feeding – clamping sleeves and mandrels

- ▶ Safe clamping in OEM quality
- ▶ Available for all common bar and pipe diameters
- ▶ Custom variants available for special cross-sections



### GUIDE JAWS

#### For special cross-sections – profiled material guide jaws

- ▶ Replace roller guide
- ▶ Use in steadies
- ▶ Matched to square and hexagonal cross-sections
- ▶ Numerous diameter variants available
- ▶ Especially durable, since made of highly wear-resistant polymer material

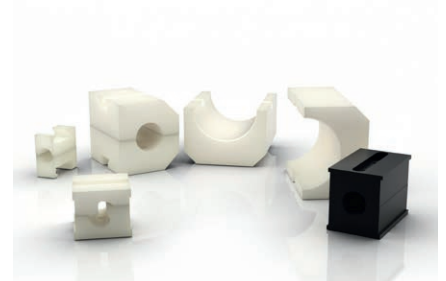

### SPINDLE LINERS

#### Bar loader and lathe made to match

- ▶ Spindle liners for adaptation of the spindle opening
- ▶ Available for a wide range of commonly available lathes
- ▶ Guarantee reliable transfer from the loader to the spindle
- ▶ Optimum guidance in the spindle opening



### BUNDLE LOADER

#### Production without an operator

- ▶ tocking capacity for up to 2500 kg bar blanks
- ▶ Simple loading by crane or forklift
- ▶ Takes the strain off personnel
- ▶ Reduces non-productive times
- ▶ Best, stable connection to the bar loader thanks to specially matched attachments



## BAR LOADING MAGAZINES FOR MULTI-SPINDLE LATHES

**Bar loading magazines for multi-spindle lathes** from FMB are based on the rear loader concept for reliable and efficient automation. The material bars are stored within the loading magazine in various ways, depending on the capacity requirement. The bar loader separates the bars and feeds them into the spindle of the multi-spindle

lathe. This takes place in an open channel with exchangeable guide inserts. A guide channel exactly matching the bar is not required. The lathe itself then gradually feeds the material bar for machining. The loading magazines are suitable for bars made of steel, NF metals and plastics with round, square and hexagonal cross-sections.

### MT 51 MA



### MT 51 BF



## PRACTICAL STORAGE CONCEPTS

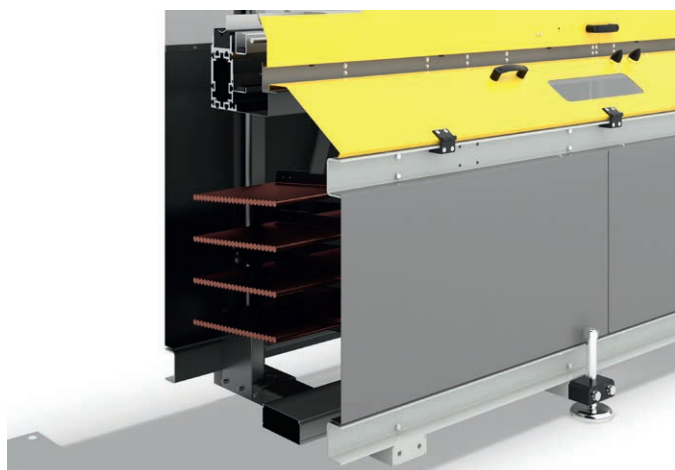

### On four levels

Depending on the diameter, the loader MT 51 MA can hold between 51 and 360 material bars on four levels. This guarantees long, interruption-free production periods. To enable bars of any diameter to be separated reliably, the angle of inclination of the material storage can be infinitely adjusted.

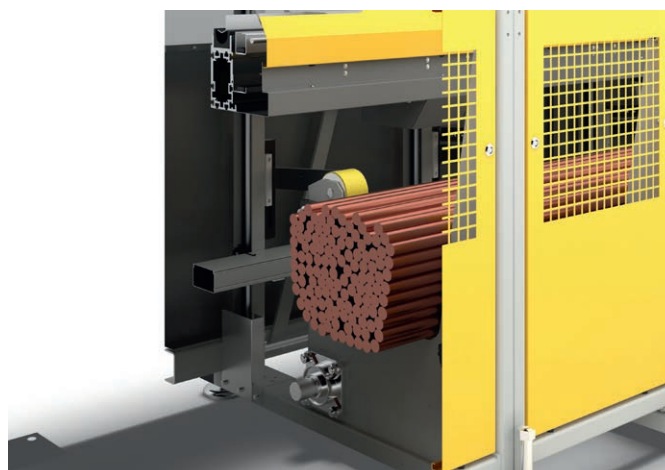

### Up to 2500 kg

With loading magazine MT 51 BF, the material bars are in an integrated bundle loader which has a capacity of up to 2500 kg. This guarantees a compact, space-saving design. In addition, large quantities of bars can be inserted quickly and easily as a complete bundle.

## CONVENIENT OPERATION

### User-friendly – mobile control panel

- ▶ Convenient operation and programming
- ▶ Robust and reliable
- ▶ Customer-specific special functions can be realised



## HIGH INSERTION FORCES

### A powerful start – feed drive

- ▶ Generally dimensioned drive motor
- ▶ Sturdy, slip-free chain gear
- ▶ Feed forces can be set infinitely at the control panel
- ▶ Reliable insertion of the bars into the collets of multi-spindle lathes

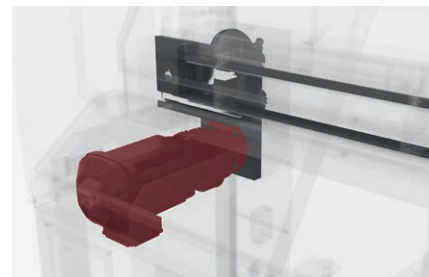

## TECHNICAL DATA

MULTI-SPINDLE LATHE		MT51 MA		MT51 BF	
Spindle-Ø (max.)	mm	51		51	
Bar length <sup>1)</sup>	mm	3300	4200	3300	4200
Bar-Ø (min. - max.)	mm	5 - 51		10 - 51	
Loading capacity	mm	1800 (4x450)		-	
Loading capacity	Items	360 with 5 mm/35 with 51 mm		-	
Loading capacity	kg	-		2500	
Remnant piece length (max.) <sup>2)</sup>	mm	-		-	
Loading time (approx.)	s	17	18	17	18
Feed speed	mm/s	0 - 900		0 - 900	
Operating voltage (50/60Hz)	V	3x 400 - 480 <sup>3)</sup>		3x 400 - 480 <sup>3)</sup>	
Power requirement	kW	2,5		2,5	
Compressed air connection	Mpa (bar)	0,6 (6)		0,6 (6)	
Weight	kg	1050	1300	1450	1800

- 1) Bar length must not exceed spindle length
- 2) Machine-dependent; disposal of remnants through the lathe
- 3) Is set on delivery according to lathe specifications

## Machine dimensions

### MT 51 MA

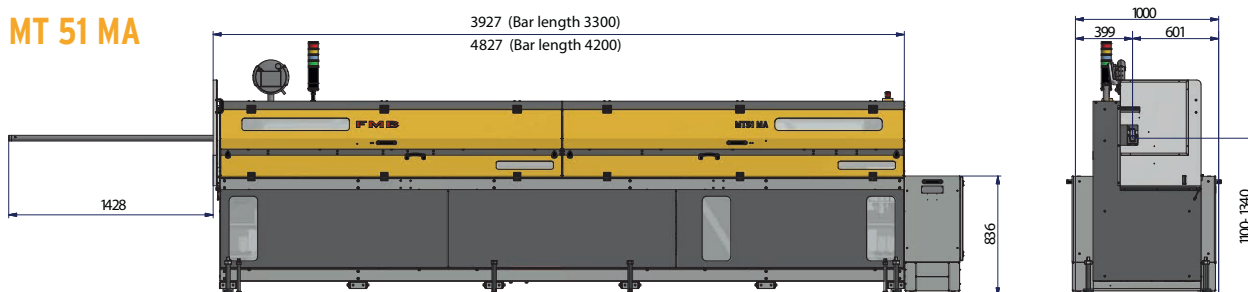

### MT 51 BF

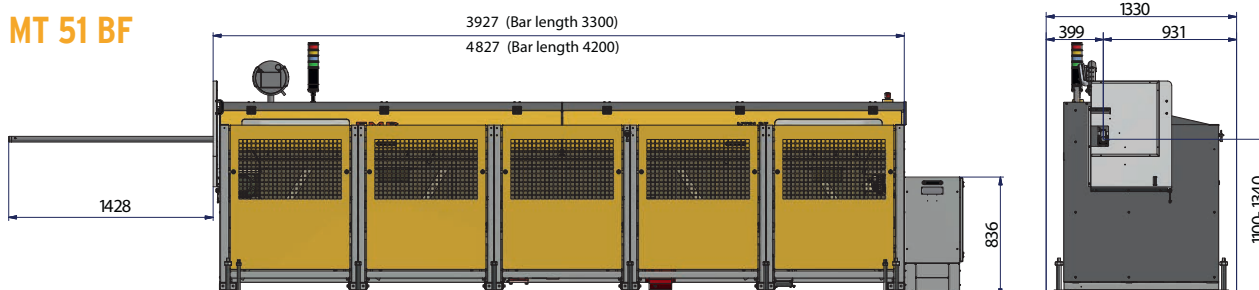

## WORKPIECE UNLOAD SYSTEMS

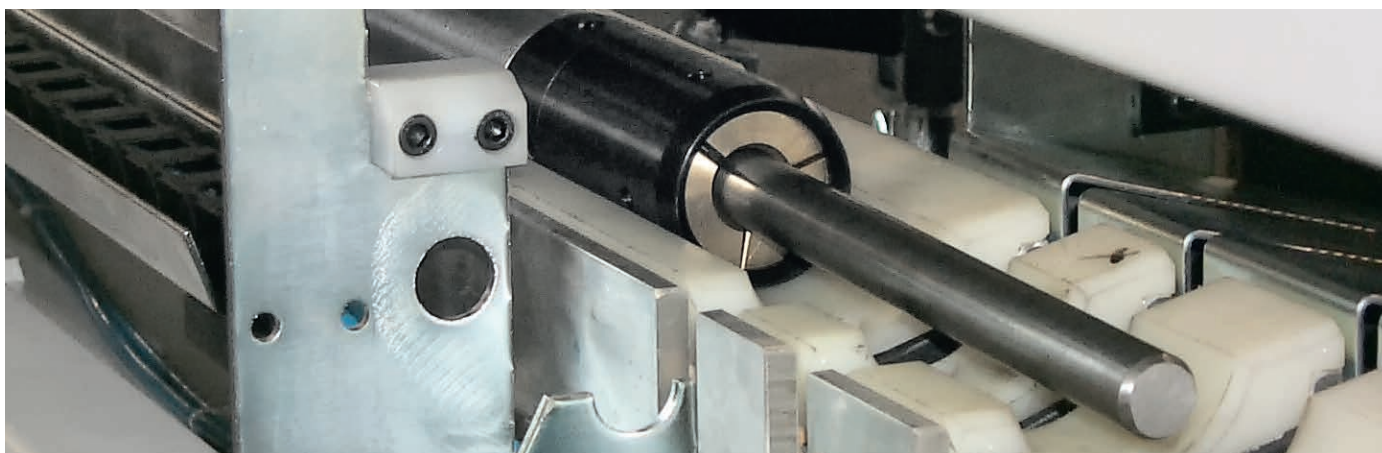

**Unloading** is also part of the complete automation concept for lathes. FMB has a solution for this, too. It is closely aligned to practical requirements. The finished workpieces are gripped by the sub-spindle and pulled out of the lathe working space. Manufacturing companies thus benefit from a reliable process that goes easy on components. The workpieces are then set down on a material storage system.

Alternatively – depending on the individual operating conditions – they can be supplied by different transport systems to the further machining, packing or assembly steps. Particularly in the case of unload systems, FMB prepares perfectly matching solutions following detailed consultation with the user.

### WORKPIECE UNLOADER VARIO E



The standardised workpiece unload system vario E removes machined workpieces from lathes through the sub-spindle. For this, the unloading bar moves the gripper of the workpiece unloader into the hollow sub-spindle. Once the gripper has clamped the workpiece, the unloading bar pulls both out. The component is then set down on a magazine at

the side. FMB designs the gripper, guide channel, ejector and magazine in collaboration with customers so that they are specifically matched to workpiece geometries and dimensions. Magazine versions include design as a depositing table or synchronised conveyor belt.



# TECHNICAL DATA



WORKPIECE UNLOAD SYSTEM		VARIO E
Spindle-Ø (max.)	mm	65
Workpiece length (max.) <sup>1)</sup>	mm	1200
Workpiece-Ø <sup>1)</sup>	mm	10 - 65
Length depositing table <sup>1)</sup>	mm	530
Length cycle belt <sup>1)</sup> (optional)	mm	1000
Unloading time (approx.) <sup>3)</sup>	s	-
Feed speed	mm/s	0 - 700
Return speed	mm/s	0 - 1000
Power requirement <sup>2)</sup>	kW	1,5
Compressed air connection	Mpa (bar)	0,6 (6)
Weight <sup>2)</sup>	kg	700

1) Special dimensions on request  
 2) Varies depending on the version  
 3) Machine-dependent

### Special features and advantages:

- ▶ Flexible adaptation through modular system
- ▶ Chip conveyor can be set up under the unloading system
- ▶ Gripper concepts adapted specifically to the workpieces:  
 e.g. spring gripper, pneumatic collet, clamping sleeve or clamping mandrel
- ▶ Unloading bar or unloading tube
- ▶ Custom options for storage: depositing table with adjustable angle of inclination, cycle belt, prism system with lateral displacement
- ▶ Integration of additional functions e.g. blow-off device for cleaning components
- ▶ Ready for Industry 4.0: optional, flexible selection of data interface for integration in any type of machine or network communication

### GRIPPER CONCEPTS

FMB selects the ideally matching gripper concept to pull components of different dimensions and contours out of the sub-spindle safely and reliably.

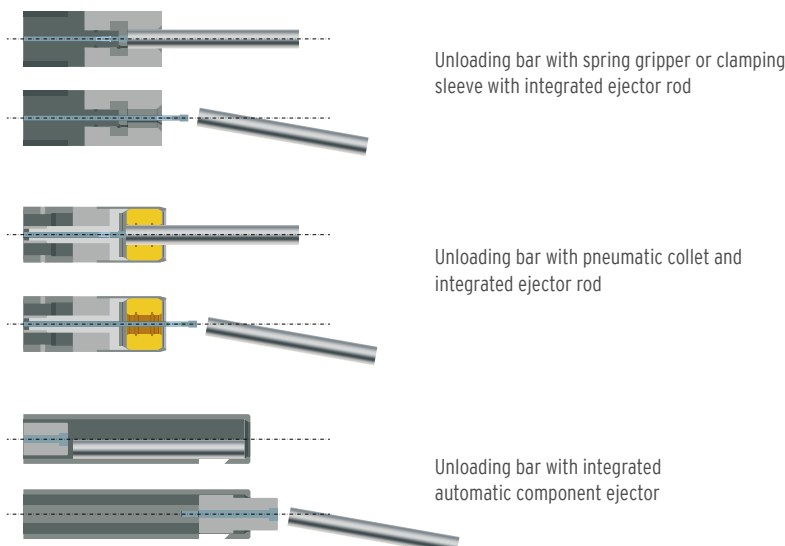

## COMPLETELY AUTOMATED LOADING AND UNLOAD SYSTEMS

For independent production without operators, FMB designs customer-specific, individual automation solutions tailored to the respective requirements and ambient conditions. Such systems are made up

of a standard loading magazine and the workpiece unload system vario E, for example, which is adapted individually to the components.



### Special advantages:

- ▶ One-stop shopping
- ▶ Economic and flexible thanks to modular system
- ▶ Components that can be specifically adapted to workpieces: bundle loaders, material storage systems, grippers, ejectors, depositing tables, cycle belt etc.
- ▶ Aligned to company requirements: e.g. large quantities, minimum cycle times, minimum workpiece diameters

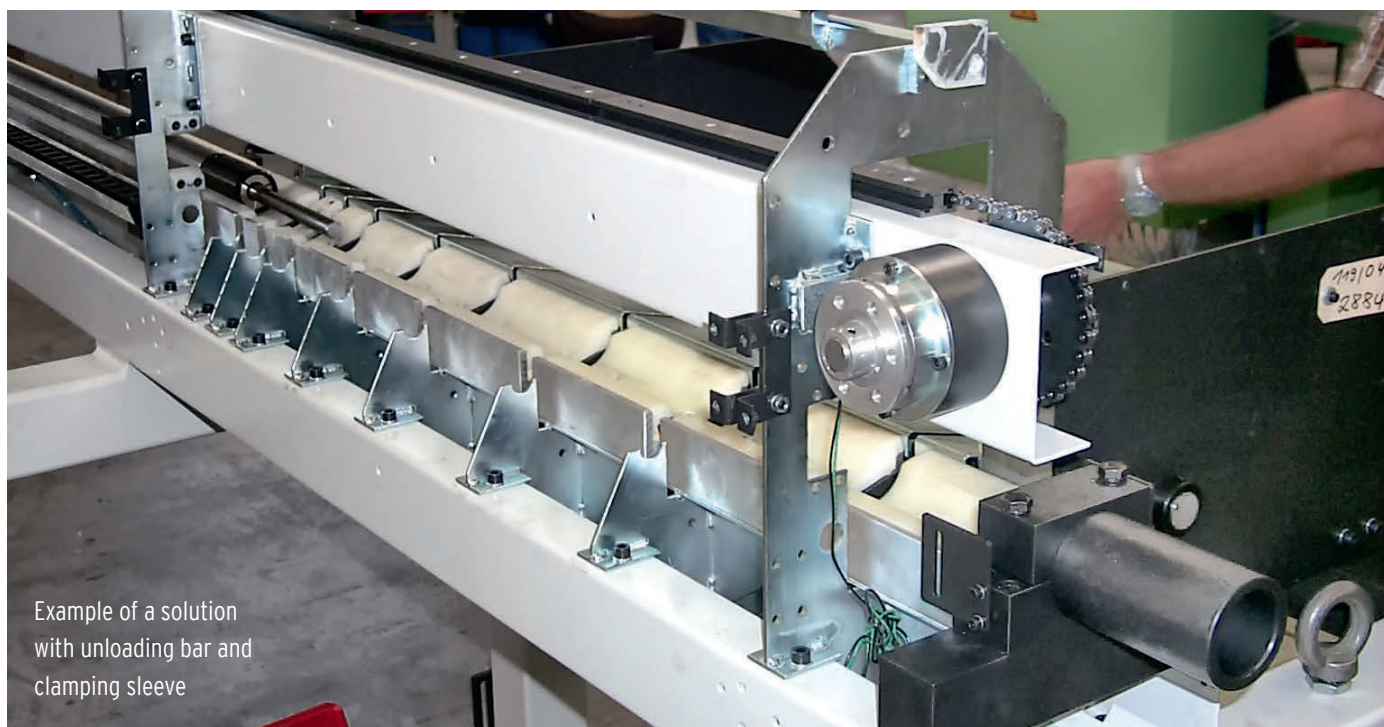

Example of a solution with unloading bar and clamping sleeve



**Made in Germany**  
Assembly process for  
loading magazines at  
FMB in Faulbach/Germany

## THE FMB GLOBAL SERVICE

### Phone support and repairs

#### Service hotline

We have set up a service hotline so that you can speak directly to the right partner if you have any questions. You will be given fast and expert help on the following subjects:

- ▶ Fault diagnosis and elimination by phone
- ▶ Coordination of service technicians on site
- ▶ Machine maintenance/repairs
- ▶ Help with identifying spare parts

#### Start-up

FMB provides help and support: Qualified service technicians install bar loaders in your production line. They prepare all the necessary data, electrical power, pneumatic and hydraulic connections and integrate the loading magazines completely in your production workflow. The result is a fully functional and reliable automation which works profitably right from the word go.

#### Training

It goes without saying that personnel briefing and training is part and parcel of the start-up process. Experts from FMB instruct your specialists on operation and programming of the automation system. If specifically requested, they can also be instructed in the maintenance and repair of bar loaders. The specialists from FMB can also provide advice, support and training at a later date - for new personnel, for example - for continued profitable operation of the automation systems. In addition, FMB also offers cross-company training for production and automation specialists. On request, we can adapt the contents specifically to your requirements.

**You can contact our service hotline as follows:**

**Monday – Friday, from 7 am – 8 pm (CET)**

**Saturday, from 8 am – 1 pm (CET)**

**Phone: +49 9392 801 801**

**E-mail: [service@fmb-machinery.de](mailto:service@fmb-machinery.de)**

**WhatsApp: +49 151 14151727**

**(only for sending text, photo and video information)**



## Spare parts and retrofit systems

### Spare parts

Automation systems from FMB are designed for a long service life and maximum reliability. If damage does occur at some point, we deliver the required spare parts extremely quickly. This also applies to bar loaders which have been in use for many years. Please send your spare parts order to:

[ersatzteilverkauf@fmb-machinery.de](mailto:ersatzteilverkauf@fmb-machinery.de)

Phone: +49 9392 801 803

Fax: +49 9392 801 228

### Used machines with warranty

If availability and efficiency count for an investment, ask about used and overhauled systems. Thanks to our constant contact to manufacturing companies all over the world, we regularly have tried-and-trusted

automation systems to offer that have been given a thorough check-up by our specialists and professionally repaired.

### Consultation and conception

You would like to introduce automation and require specialist information from hand-picked experts? Our specialists work closely with your production planners to prepare a tailor-made concept, suggest

the matched automation solution and provide advice on integration in your production environment.

### Just give us a call:

**+49 9392 801 801**



## TAILORED TO CUSTOMER WISHES

### Our solutions serve your success

Our team stands for comprehensive know-how and top quality. We have been developing and producing high-quality automation technology for machine tools since 1980. Our bar loaders are renowned and valued the world over for their reliable function and mature technology.

Day after day, our work focuses on our customers' requirements in the terms of economical and highly productive manufacturing. Over the last decades, this has resulted in the development of a wide range of automation technology for loading and unloading machine tools.

#### For lathes:

- ▶ Bar loaders for 0.8 to 100 mm bar diameter and up to 8500 mm bar length or even longer
- ▶ Loading systems for single-spindle lathes and CNC turning centres
- ▶ Bar loaders for multi-spindle lathes
- ▶ Workpiece unload systems through the sub-spindle

#### For machining and turning centres:

- ▶ Compact, universal robot cells for the loading and unloading of cylindrical and cubic blanks and components
- ▶ Integrated additional and reworking
- ▶ iMeasuring and testing technology integrated in the process for 100% quality check



Our automation solutions are completely aligned to the wishes and requirements of our customers. At FMB you have the choice between numerous standard systems as well as versions configured specifically to your requirements. If you need to load and unload turning and machining centres quickly, universally and at low cost, you will find the version you need in our attractive range of bar loaders and robot cells. Our solutions impress with their mature technology, top quality and absolute reliability.

All standard systems from FMB offer maximum flexibility for a wide range of diameters and dimensions. Our automation systems can be set up and programmed quickly and easily. They thus ensure significantly higher productivity on your production line. If automation is to fulfil further tasks such as reworking or 100% quality control, our specialists will configure a customised solution that exactly matches your company environment.

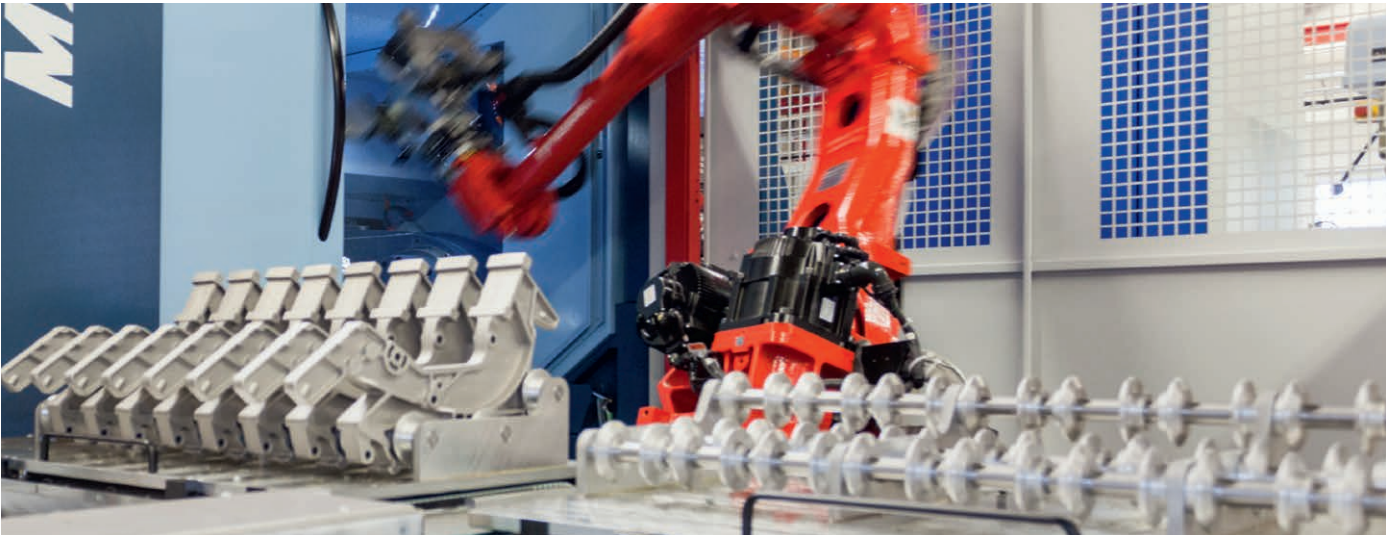

## UNIROBOT HANDLING SYSTEMS

**UNIROBOT** handling systems from FMB are flexible and efficient industrial robot solutions for the automated loading and unloading of systems in industrial production. Our portfolio includes standardised **UNIROBOT**-automation cells as well as tailor-made custom solutions which we develop matched to your requirements. Modern FANUC or YASKAWA industrial robots handle workpieces of a wide range of different geometries and weights. With a wide range of systems for component storage such as e.g. pallets, trolleys, conveyor belts, carousel

storage and bulk material feeds, we have the matching solution for all production and material flow requirements. Optimum process additions such as e.g. measuring, deburring, cleaning, preservation, marking and labelling of the workpieces are integrated in our handling systems as required, thus shortening production times while increasing efficiency at the same time. Standardised interfaces make the integration of our handling systems in the production process easier. A reliable safety concept covers all safety requirements of the automation process.

## WORKPIECE MEASURING SYSTEM UNIPROVE

The **UNIPROVE** workpiece measuring system from FMB is a universal measuring and testing system that can be both integrated in our **UNIROBOT** handling systems and offered as a stand-alone system. We develop, manufacture and program every **UNIPROVE** workpiece measuring system to match your individual requirements and wishes. The use of tactile, pneumatic and optical measuring technology allows a wide range of measuring and testing jobs to be realised. Material faults such as e.g. cracks, shrink holes or occlusion can be detected using eddy current testing systems. The 100% control often required in day-to-day industrial applications can be carried out parallel to the productive time thanks to integration in our **UNIROBOT** handling systems. Both feedback of the measured values to the machine tool and logging of the measured values are among the options available.

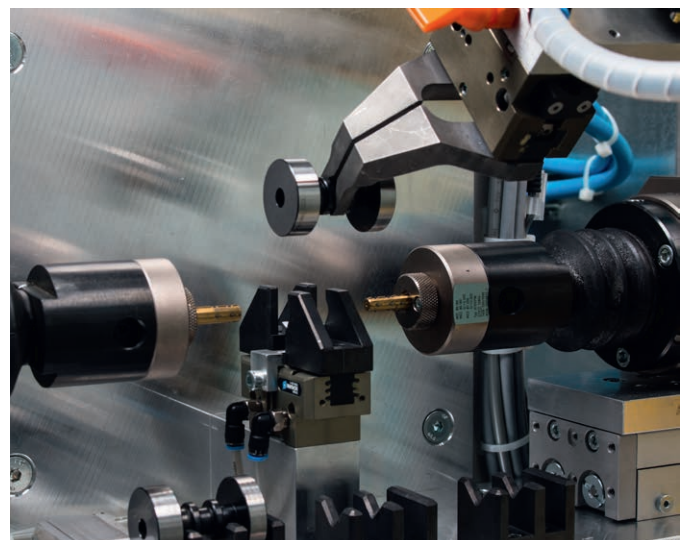

**FMB**  
MASCHINENBAU

FMB Maschinenbaugesellschaft mbH & Co. KG  
Paul-Hohe-Straße 1  
D-97906 Faulbach  
Phone +49 9392 8010  
Fax +49 9392 80120  
info@fmb-machinery.de  
www.fmb-machinery.de

Print date 08/2017

We reserve the right to make technical changes